

FORESTRY & GARDENING accessories

products catalogue
2013 - 2014 A01



**Our
experience
in your
hands**

man, technology and nature



WORLDWIDE ITALIAN TALENT

When TECOMEK was established in 1985, a new production and commercial company made its debut on the world market for forestry and gardening machinery.

About twenty-five years later the company has consolidated its success, by distribution of more than 10.000 articles in 50 countries. The secret of this success lies in the company 's philosophy, in the common spirit that moves all ist staff and its production and commercial organization – a winning and innovative spirit. Tecomec combines a remarkable operating versatility with the typically Italian business creativity. Thanks to his rare ability to understand and forsee the market needs, Tecomec punctually renews its production lines to offer always latest-concept products. The company operates to the severest quality standards; its products are certified according to safety standards in force both in European Union and in the major extra EU countries.

ACCESSORIES THAT ALWAYS MAKE A "SHARP" DIFFERENCE

The complete range of electric saw chain grinders is Tecomec's major series. As a matter of fact, "Jolly" has become the name of the electric grinding machine across the world. Thanks to its success, several models with different technical characteristics have been developed to satisfy all users requirements.

However, electric grinders are only a part of a larger line of accessories for saw chain and brushcutters, thanks to which Tecomec gained a worldwide leadership on the market.

index



 **Chain saw accessories** 2-65

 **Brushcutters accessories** 66-145

General conditions of sale 146-147

chain saw accessories

Forestry and gardening accessories



chain saw accessories

tick marks legend



Particularly suitable for professional saw chain maintenance technicians



Range of chains on which it can be used



Can be also used on chains requiring "Down Angle" sharpening



Can be also used on 3/4" pitch chains.



Packaging:
NYLON BAG
containing bulk items



Packaging:
CLAMSHELL
containing bulk items



Packaging:
CARTON BOX
containing bulk items

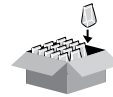

Master pack:
CARTON BOX
containing single nylon bags

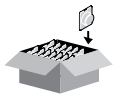

Master pack:
CARTON BOX containing
single clamshells

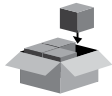

Master pack:
CARTON BOX containing
single boxes

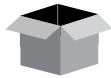

Master pack:
CARTON PALLET containing
bulk items



Max quantity
per PALLET



SUPERJOLLY

electric chain grinder

GRINDING ACCURACY AND BEST PERFORMANCE. HYDRAULIC CLAMPING.

Combined to the Tecomec Jolly grinder features for best sharpening accuracy an Hydraulic assist semi-automatic device for higher efficiency and time saving.

- The chain is automatically clamped by the grinder head centering operation.
- Self center adjustment knob: the chain is always aligned in perfect center with the vise turning axis.
- Most reliable sharpening of all sizes of saw chains: from 1/4" to 3/4" pitch.



PROFESSIONAL USE



ALL TYPE OF CHAIN



3/4" PITCH CHAINS



DOWN ANGLE ADJUSTMENT

plugs

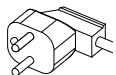

230 V~

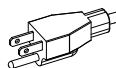

120 V~

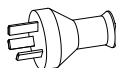

230 V~ AUS

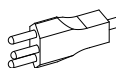

230 V~ CH

P/N	VOLTAGE		RATED POWER W	MAX SPEED min ⁻¹	CHAIN PITCH	EAN13 CODE
	V~	Hz				
11509004	230	50	214	2800	1/4"	8032706105194
11509006	120	60	300	3400	.325"	8032706105200
CH 11509012	230	50	214	2800	3/8"	8032706105194
AUS 11509013	230	50	214	2800	.404" 3/4"	8032706105194

PACKAGING:

1 pc x Carton Box
43,5x25,5x32,5 cm
9,5 kg



Q.TY x MASTER PACK: 1 pc

MAX Q.TY x PALLET: 40 pcs
TOTAL WEIGHT: 400,0 kg



ORDER MULTIPLES OF: 1 pc

certifications



230 V~ 50 Hz



LISTED GRINDING MACHINE 41DA

120 V~ 60 Hz

packaging



► provided with following items



GRINDING WHEEL

- 1 pc Thickness 3,2 mm for: 1/4" - .325" - 3/8" chains
- 1 pc Thickness 4,7 mm for: .325" - 3/8" - .404" chains
- 1 pc Thickness 8,0 mm for: 3/4" chains + depth gauge



DRESSING BRICK

- 1 pc



TEMPLATE

- 1 pc



WRENCHES

- 1 pc HEX. 4 mm
- 1 pc HEX. 5 mm



TEMPLATE

- 1 pc 3/4" gauge template

► highlights

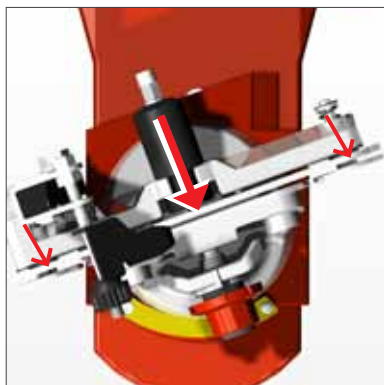

WISE PLATES CLAMPING

Most uniform and precise chain clamping: the cylinder actionated by the head lowering thrusts the plates and locks the chain.



SELF CENTER ADJUSTMENT KNOB

Following the marks in accordance with different pitches the chain will be always aligned in perfect center with the vise turning axis.



CYLINDER PROTECTION

JOLLYStar

electric chain grinder



PROFESSIONAL USE



1/4" ± .404" PITCH CHAIN



DOWN ANGLE ADJUSTMENT

BEST GRIND AND CHAIN PERFORMANCE ENSURED! EASY AND RELIABLE.

New concept bench chain grinder designed for perfect keeping of the original saw chain cutting angles.

- Self-centering chain vise: equal and consistent grinding angles without additional adjustments
- Clear and evident setting steps since based on saw chain geometry
- Correct position of grinder's head pivot axis on the chain on all positions
- Most reliable sharpening of sizes of saw chains: from 1/4" to 404" pitch.
- Sharpens 3/4" pitch chain when fitted with attachment our accessories P/N: D00400000 + K00200323 + K00204008 (to be ordered separately).



plugs

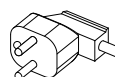

230 V~

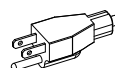

120 V~

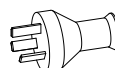

230 V~ AUS

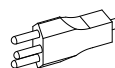

230 V~ CH

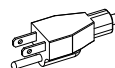

100 V~ JAP

P/N	VOLTAGE		RATED POWER W	MAX SPEED min ⁻¹	CHAIN PITCH	EAN13 CODE
	V~	Hz				
11359001	230	50	214	2800	1/4" .325" 3/8" .404"	8032706102582
11369001	120	60	300	3400		8032706102582
CH 11359002	230	50	214	2800		8032706102582
AUS 11359003	230	50	214	2800		8032706102582
JAP 11359006	100	50/60	150/100	3000/3500		

PACKAGING:
1 pc x Carton Box
30x37x26 cm
8,2 kg



Q.TY x MASTER PACK: 4 pcs
MASTER CARTON: 63x40x54 cm
TOTAL WEIGHT: 34,0 kg

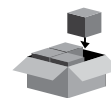

ORDER MULTIPLES OF: 4 pcs

MAX Q.TY x PALLET: 56 pcs
TOTAL WEIGHT: 496,0 kg



certifications



230 V~ 50 Hz



LISTED GRINDING MACHINE 41DA

120 V~ 60 Hz



100 V~ 50/60 Hz

packaging



► provided with following items



GRINDING WHEEL

- 1 pc Thickness 3,2 mm for: 1/4" - .325" - 3/8" chains
- 1 pc Thickness 4,7 mm for: .325" - 3/8" - .404" chains
- 1 pc Thickness 6,0 mm for depth gauge



DRESSING BRICK

- 1 pc



TEMPLATE

- 1 pc



WRENCHES

- 1 pc HEX. 4 mm
- 1 pc HEX. 5 mm

► accessories to be ordered separately for 3/4" chain

P/N D00400000

3/4" Gauge template



PACKAGING: 10 pcs x Nylon Bag
TOTAL WEIGHT: 0,2 kg



ORDER MULTIPLES OF: 10 pcs

P/N K00200323

Chain stop for
3/4" chain pitch.
Fits JollyStar only



PACKAGING: 5 pcs x Nylon Bag
TOTAL WEIGHT: 0,2 kg



ORDER MULTIPLES OF: 5 pcs

P/N K00204008

Grinding wheel for:
3/4" chain pitch.

th. 8,0 mm (5/16")



PACKAGING: 15 pcs x Carton Box
MASTER CARTON: 24x18,5x18,5 cm
TOTAL WEIGHT: 5,4 kg



ORDER MULTIPLES OF: 15 pcs

COMPACT

electric chain grinder



Professional evolution of the most sold chain grinder in the world.

Sturdy and reliable.

Suitable for most common pitch chains and types.

- Sharpens 3/4" pitch chain when fitted with attachment our special vise P/N 1102900 (to be ordered separately).
- Sharpens DOWN ANGLE chains (10° tilting) when fitted with attachment our P/N: 1135026 (to be ordered separately).



PROFESSIONAL USE



1/4" ÷ .404"
PITCH CHAIN

plugs

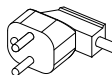

230 V~

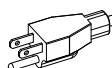

120 V~

P/N	VOLTAGE		RATED POWER W	MAX SPEED min ⁻¹	CHAIN PITCH	EAN13 CODE
	V~	Hz				
11359004	230	50	214	2800	1/4" .325"	8032706103114
11369000	120	60	300	3400	3/8" .404"	8032706103114

PACKAGING:

1 pc x Carton Box
29,5 x 37 x 26 cm
8,1 kg



Q.TY x MASTER PACK:

4 pcs
MASTER CARTON:
63x40x54 cm
TOTAL WEIGHT:

34,0 kg

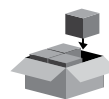

ORDER MULTIPLES OF: 4 pcs

MAX Q.TY x PALLET

TOTAL WEIGHT:

56 pcs
496,0 kg



certifications



230 V~ 50 Hz



LISTED GRINDING MACHINE 41DA

120 V~ 60 Hz

packaging



COMPACT

► provided with following items



GRINDING WHEEL

- 1 pc Thickness 3,2 mm for: 1/4" - .325" - 3/8" chains
- 1 pc Thickness 4,7 mm for: .325" - 3/8" - .404" chains
- 1 pc Thickness 6,0 mm for depth gauge



DRESSING BRICK

- 1 pc



TEMPLATE

- 1 pc



WRENCHES

- 1 pc HEX. 4 mm
- 1 pc HEX. 5 mm

COMPACT

► accessories to be ordered separately

P/N 1102900

Special vise to be fitted to COMPACT chain grinder body, for 3/4" pitch chains.

► Provided with following items

GRINDING WHEEL

- 1 pc Thickness 8,0 mm (5/16") for: 3/4" pitch chains.



TEMPLATE

- 1 pc 3/4" gauge template.



PACKAGING: 14 pcs x Carton Box
MASTER CARTON: 21,5x17,5x12,5 cm
TOTAL WEIGHT: 1,4 kg



ORDER MULTIPLES OF: 1 pcs

P/N 1135026

Special vise to be fitted to COMPACT chain grinder body, for DOWN ANGLE adjustment (up to 10° tilting).
For 1/4" - .325" - 3/8" - .404" pitch chains.



PACKAGING: 1 pc x Carton Box
MASTER CARTON: 19,5x17,5x12 cm
TOTAL WEIGHT: 1,4 kg



ORDER MULTIPLES OF: 1 pc

MIDI Jolly

electric chain grinder



1/4" ÷ .404"
PITCH CHAIN



Compact and reliable grinder, professional and accurate grinding performances.

The "MIDI JOLLY" features permanent-magnet motor capable to provide excellent performances under the most heavy strain.

plugs

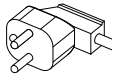

230 V~

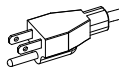

120 V~

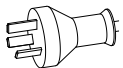

230 V~ AUS

P/N	VOLTAGE		RATED POWER	MAX SPEED	CHAIN PITCH	EAN13 CODE
	V~	Hz	W	min ⁻¹		
1190910	230	50	85	5000	1/4"	8032706103534
1190915	120	60	85	5000	.325" 3/8"	8032706103534
AUS 1190909	230	50	85	5000	.404"	8032706103534

PACKAGING:
1 pc x Carton Box
30x25x24 cm
3,1 kg



Q.TY x MASTER PACK: 6 pcs
MASTER CARTON: 78x30x43 cm
TOTAL WEIGHT: 19,5 kg

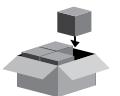

ORDER MULTIPLES OF: 6 pcs

MAX Q.TY x PALLET: 96 pcs
TOTAL WEIGHT: 332,0 kg



certifications



230 V~ 50 Hz



packaging



► provided with following items



GRINDING WHEEL

1 pc Thickness 3,2 mm for: 1/4" - .325" - 3/8" chains



DRESSING BRICK

1 pc



TEMPLATE

1 pc

► accessories to be ordered separately

P/N K00204017

Grinding wheel for:
.325" - 3/8" - .404" chain pitch.

th. 4,7 mm (3/16")



PACKAGING: 20 pcs x Carton Box
MASTER CARTON: 24x18,5x18,5 cm
TOTAL WEIGHT: 2,9 kg



ORDER MULTIPLES OF: 20 pcs

P/N K00204018

Grinding wheel for:
depth gauge.

th. 6,0 mm (1/4")



PACKAGING: 15 pcs x Carton Box
MASTER CARTON: 24x18,5x18,5 cm
TOTAL WEIGHT: 2,9 kg



ORDER MULTIPLES OF: 15 pcs

P/N 1185049

Bracket for **MidiJolly** and **SharpBoy** chain grinders.

PACKAGING: 5 pcs x Carton Box
TOTAL WEIGHT: 0,652 kg



ORDER MULTIPLES OF: 5 pcs

EASYGrinder

electric chain grinder



1/4" ÷ .404"
PITCH CHAIN

Electric chain bench grinder, this new compact, economical machine has the features and controls to provide a precise grind with professional results.

Cam lever chain clamp holds chain steady.
The vise angle guide is easily adjusted.
High torque grinder quickly sharpens 1/4" to .404" pitch saw chains.



plugs

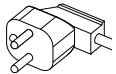

230 V~

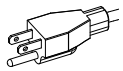

120 V~

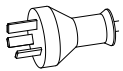

230 V~ AUS

P/N	VOLTAGE		RATED POWER	MAX SPEED	CHAIN PITCH	EAN13 CODE
	V~	Hz	W	min ⁻¹		
11909001	230	50	85	5000	1/4"	8032706104777
1190925	120	60	85	5000	.325" 3/8"	8032706104784
AUS 11909003	230	50	85	5000	.404"	8032706104784

PACKAGING:
1 pc x Carton Box
30x25x24 cm
3,1 kg



Q.TY x MASTER PACK: 6 pcs
MASTER CARTON: 78x30x43 cm
TOTAL WEIGHT: 19,5 kg

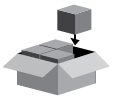

ORDER MULTIPLES OF: 6 pcs

MAX Q.TY x PALLET 96 pcs
TOTAL WEIGHT: 332,0 kg



certifications



230 V~ 50 Hz



packaging



EASYGrinder

► provided with following items



GRINDING WHEEL

1 pc Thickness 3,2 mm for: 1/4" - .325" - 3/8" chains



DRESSING BRICK

1 pc



TEMPLATE

1 pc

EASYGrinder

► accessories to be ordered separately

P/N K00204017

Grinding wheel for:
.325" - 3/8" - .404" chain pitch.

th. 4,7 mm (3/16")



PACKAGING: 20 pcs x Carton Box
MASTER CARTON: 24x18,5x18,5 cm
TOTAL WEIGHT: 2,9 kg



ORDER MULTIPLES OF: 20 pcs

P/N K00204018

Grinding wheel for:
depth gauge.

th. 6,0 mm (1/4")



PACKAGING: 15 pcs x Carton Box
MASTER CARTON: 24x18,5x18,5 cm
TOTAL WEIGHT: 2,9 kg



ORDER MULTIPLES OF: 15 pcs

P/N 1185049

Bracket for **MidiJolly** and **SharpBoy** chain grinders.

PACKAGING: 5 pcs x Carton Box
TOTAL WEIGHT: 0,652 kg



ORDER MULTIPLES OF: 5 pcs

SHARP Boy

electric chain grinder



1/4" ÷ .404"
PITCH CHAIN

POWER FULL MOTOR

Follows the Tecomec tradition of design and manufacturing accuracy: made in compliance with main safety standards.

The SHARP BOY grinder classifies in its market segment for operator's friendly features:

- Easy to install and start
- Same safety devices as larger grinding machines
- Chain clamping vise in best position for visibility and chain control and advancement.
- Large Ø105 mm (4-1/8") grinding wheel ensures longer operation and "pro"-alike consistency of chain profile results, by keeping correct grinding geometry through much lower chain heating.



plugs

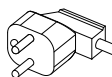

230 V~

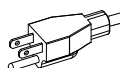

120 V~

P/N	VOLTAGE		RATED POWER W	MAX SPEED min ⁻¹	CHAIN PITCH	EAN13 CODE
	V~	Hz				
11809001	230	50	75	4500	1/4" .325"	8032706102575
11809002	120	60	75	4500	3/8" .404"	8032706102575

PACKAGING:

1 pc x Carton Box
29,5x25x20,3 cm
2,6 kg



Q.TY x MASTER PACK: 6 pcs

MASTER CARTON: 78x30x43 cm

TOTAL WEIGHT: 16,8 kg

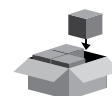

ORDER MULTIPLES OF: 6 pcs

MAX Q.TY x PALLET 96 pcs

TOTAL WEIGHT: 289,0 kg



certifications



230 V~ 50 Hz

packaging



provided with following items



GRINDING WHEEL

1 pc Thickness 3,2 mm for: 1/4" - .325" - 3/8" chains



TEMPLATE

1 pc

accessories to be ordered separately

P/N K00204017

Grinding wheel for:
.325" - 3/8" - .404"
chain pitch.



th. 4,7 mm (3/16")

PACKAGING: 20 pcs x Carton Box
MASTER CARTON: 24x18,5x18,5 cm
TOTAL WEIGHT: 2,9 kg



ORDER MULTIPLES OF: 20 pcs

P/N K00204018

Grinding wheel for:
depth gauge.



th. 6,0 mm (1/4")

PACKAGING: 15 pcs x Carton Box
MASTER CARTON: 24x18,5x18,5 cm
TOTAL WEIGHT: 2,9 kg



ORDER MULTIPLES OF: 15 pcs

P/N 1185049

Bracket for **MidiJolly**
and **SharpBoy** chain
grinders.



PACKAGING: 5 pcs x Carton Box
TOTAL WEIGHT: 0,652 kg



ORDER MULTIPLES OF: 5 pcs

highlights

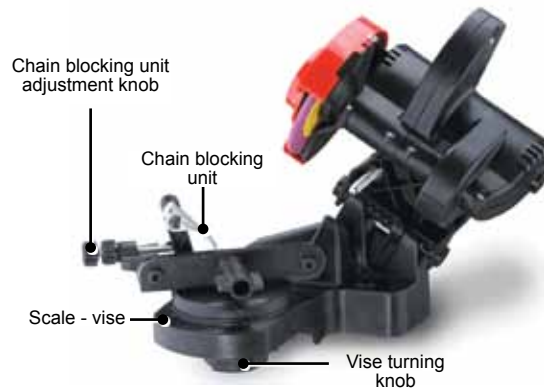
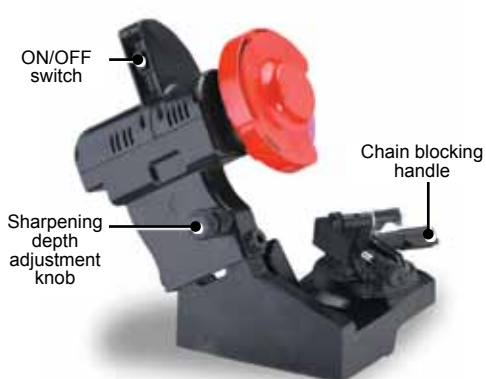

Grinding Wheels

for chain grinders series : **Jolly Star - Super Jolly - Jolly - Compact**

Wheels specifications

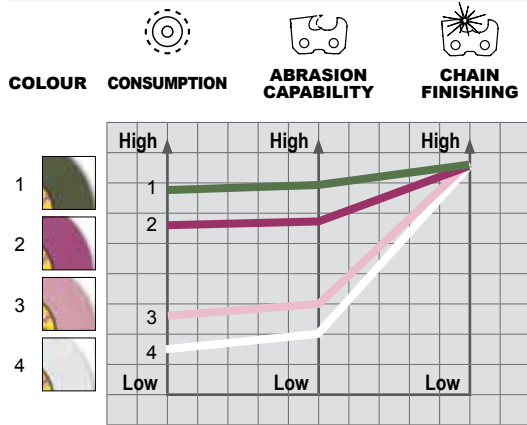

Wheels use

WHEEL THICKNESS		PITCH CHAIN
3,2 mm (1/8")	→	1/4" .325" 3/8"
4,7 mm (3/16")	→	.325" 3/8" .404"
6,0 mm (1/4")	→	for depth gauge
8,0 mm (5/16")	→	3/4"

Use this P/N to order



SUITABLE TO:

Jolly Star



Super Jolly



Jolly



Compact



TYPE	WHEEL SIZE		THICKNESS	OLD P/N	NEW P/N	ORDER MULTIPLES OF	PACKAGING			
	Ø EXT.	Ø INT.								
	145	5-3/4"	22,2	7/8"	3,2	1/8"	/			
	145	5-3/4"	22,2	7/8"	4,7	3/16"	01005001		K00204009	20 pcs
	145	5-3/4"	22,2	7/8"	3,2	1/8"	1005231	K00204005	25 pcs	
	145	5-3/4"	22,2	7/8"	4,7	3/16"	1005233	K00204006	20 pcs	
	145	5-3/4"	22,2	7/8"	6,0	1/4"	1005232	K00204007	15 pcs	
	145	5-3/4"	22,2	7/8"	8,0	5/16"	01005000	K00204008	15 pcs	240x185x185 mm 5,4 kg
	145	5-3/4"	22,2	7/8"	3,2	1/8"	01005003	01005003	20 pcs	
	145	5-3/4"	22,2	7/8"	4,7	3/16"	01005004	01005004	20 pcs	
	145	5-3/4"	22,2	7/8"	6,0	1/4"	01005005	01005005	20 pcs	290x170x170 mm 3,2 kg
	145	5-3/4"	22,2	7/8"	3,2	1/8"	01005015	K00204010	25 pcs	
	145	5-3/4"	22,2	7/8"	4,7	3/16"	01005014	K00204011	20 pcs	

SELLING OUT

Grinding Wheels

for chain grinders series : **Midi Jolly - Easy Grinder - Sharp Boy - Baby Jolly**
Mini Jolly + EFFELLE suitable for PROGRESS

Wheels specifications

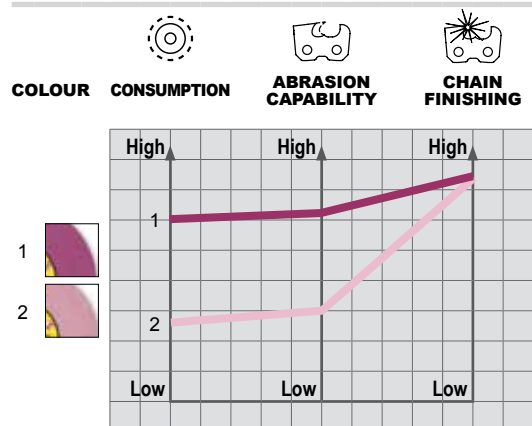

Wheels use

WHEEL THICKNESS		PITCH CHAIN
3,2 mm (1/8")	→	1/4" .325" 3/8"
4,7 mm (3/16")	→	.325" 3/8" .404"
6,0 mm (1/4")	→	for depth gauge

SUITABLE TO:



Use this P/N to order



TYPE	WHEEL SIZE		THICKNESS	OLD P/N	NEW P/N	ORDER MULTIPLES OF	PACKAGING			
	Ø EXT.	Ø INT.								
	105	4-1/8"	22,2	7/8"	3,2	1/8"	1190051	K00204016	25 pcs	
	105	4-1/8"	22,2	7/8"	4,7	3/16"	1190052	K00204017	20 pcs	
	105	4-1/8"	22,2	7/8"	6,0	1/4"	1190053	K00204018	15 pcs	
	105	4-1/8"	22,2	7/8"	3,2	1/8"	01005006	01005006	20 pcs	
	105	4-1/8"	22,2	7/8"	4,7	3/16"	01005007	01005007	20 pcs	

SUITABLE TO:

OLD CHAIN GRINDER MODELS



Use this P/N to order



TYPE	WHEEL SIZE		THICKNESS	SINGLE P/N	ORDER MULTIPLES OF	PACKAGING				
	Ø EXT.	Ø INT.								
	100	4-7/8"	16	5/8"	4,7	3/16"	1185149	23 pcs		240x185x185 mm 2,5 kg
	123	4.84"	22,2	7/8"	4,5	3/16"	1005034	24 pcs		290x170x170 mm 2,9 kg

Accessories

for chain grinders



P/N	DESCRIPTION
-----	-------------

1005040	Dressing brick
---------	----------------

PACKAGING:	20 pc x Nylon Bag
Q.TY x MASTER PACK:	20 pcs
TOTAL WEIGHT:	1,4 kg



ORDER MULTIPLES OF: 20 pcs



P/N	DESCRIPTION
-----	-------------

1112001	Template
---------	----------

PACKAGING:	20 pc x Nylon Bag
Q.TY x MASTER PACK:	20 pcs



ORDER MULTIPLES OF: 20 pcs



P/N	DESCRIPTION
-----	-------------

3052004	Wrench 4mm
---------	------------

3052005	Wrench 5mm
---------	------------

PACKAGING:	20 pc x Nylon Bag
Q.TY x MASTER PACK:	20 pcs



ORDER MULTIPLES OF: 20 pcs



P/N	DESCRIPTION
-----	-------------

D00400000	3/4" Gauge template
-----------	---------------------

PACKAGING:	10 pc x Nylon Bag
Q.TY x MASTER PACK:	10 pcs
TOTAL WEIGHT:	0,2 kg



ORDER MULTIPLES OF: 10 pcs

DELuxe

manual sharpener



PROFESSIONAL
USE



For precision saw chain filing with 6"-8" round files as well as flat and triangular depth gauge files. File not included.
Professional model.

P/N	DESCRIPTION	EAN13 CODE
1147981	manual sharpening De Luxe CLAMSHELL	8032706104807

PACKAGING:

1 pc x
Clamshell



Q.TY x MASTER PACK: 24 pcs

MASTER CARTON: 64x43x23,5 cm

TOTAL WEIGHT: 14,2 kg

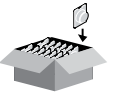

ORDER MULTIPLES OF: 24 pcs

► Use

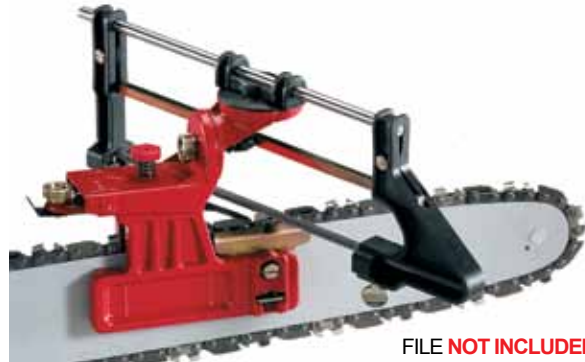

FILE **NOT INCLUDED**

► accessories to be ordered separately:

Chain saw files

P/N	ROUND FILE Ø		FILE LENGTH	
	in	mm	in	mm
1010026	5/32"	4,0	8"	200
1011014	11/64"	4,5	8"	200
1011015	3/16"	4,8	8"	200
L00200000	13/64"	5,2	8"	200
1012009	7/32"	5,5	8"	200



PACKAGING:

12 pcs x Carton Box

Q.TY x MASTER PACK: 300 pcs

TOTAL WEIGHT: 8,5 kg



ORDER MULTIPLES OF: 300 pcs

SUPER**Rapid**

manual sharpener



For precision saw chain filing with 6"-8" round files as well as flat and triangular depth gauge files. File not included.

P/N	DESCRIPTION	EAN13 CODE
1107902	manual sharpening Super Rapid CLAMSHELL	8032706104814

PACKAGING:
1 pc x
Clamshell



Q.TY x MASTER PACK: 30 pcs
MASTER CARTON: 58x40x35 cm
TOTAL WEIGHT: 13,5 kg

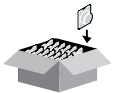

ORDER MULTIPLES OF: 30 pcs

► Use

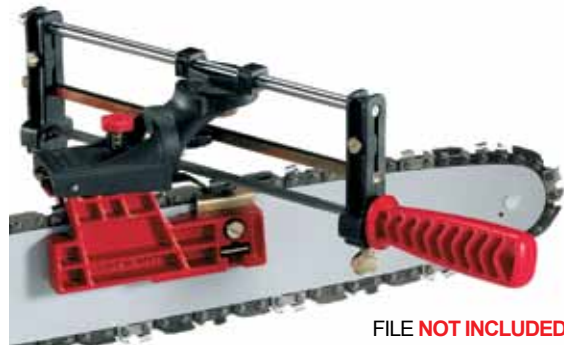

FILE NOT INCLUDED

► accessories to be ordered separately:

Chain saw files

P/N	ROUND FILE Ø		FILE LENGTH	
	in	mm	in	mm
1010026	5/32"	4,0	8"	200
1011014	11/64"	4,5	8"	200
1011015	3/16"	4,8	8"	200
L00200000	13/64"	5,2	8"	200
1012009	7/32"	5,5	8"	200



PACKAGING: 12 pcs x Carton Box
Q.TY x MASTER PACK: 300 pcs
TOTAL WEIGHT: 8,5 kg



ORDER MULTIPLES OF: 300 pcs

Filing Vise



ERGONOMICS

Tightening of the chainsaw bar with the minimal effort.
Machined surface for a more effective locking of the chainsaw bar.

EFFICIENT

Works on prepared side only.
Perfectly vertical Insertion.
Reinforced pin to avoid folds and breakings.

P/N	DESCRIPTION	EAN13 CODE
10909007	Filing Vise - CLAMSHELL	8032706105972

PACKAGING:

1 pc x
Clamshell



Q.TY x MASTER PACK: 25 pcs

MASTER CARTON: 41x25x15 cm

TOTAL WEIGHT: 9,7 kg

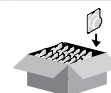

ORDER MULTIPLES OF: 25 pcs

packaging



highlights

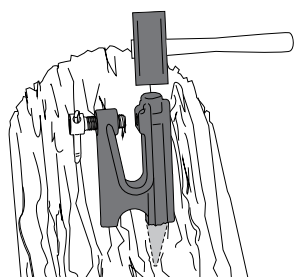

INSERTION

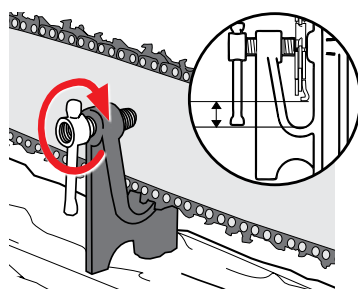

TIGHTENING

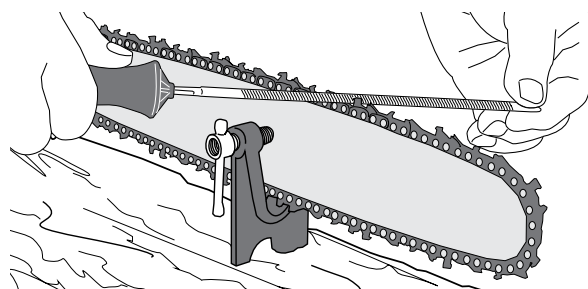

SHARPENING

Fling Vise

complete with chain stop pawl





Fling Vise complete with chain stop pawl

ERGONOMICS

Tightening of the chainsaw bar with the minimal effort.
Machined surface for a more effective locking of the chainsaw bar.
Automatic locking of chain.

EFFICIENT

Works on prepared side only.
Perfectly vertical Insertion.
Reinforced pin to avoid folds and breakings.
Adjustable on every bar heights.

P/N	DESCRIPTION	EAN13 CODE
10909008	Filing Vise with chain stop pawl CLAMSHELL	8032706106078
PACKAGING:		
1 pc x Clamshell		Q.TY x MASTER PACK: 25 pcs
		MASTER CARTON: 41x25x15 cm
		TOTAL WEIGHT: 10,5 kg
		
ORDER MULTIPLES OF: 25 pcs		

► highlights

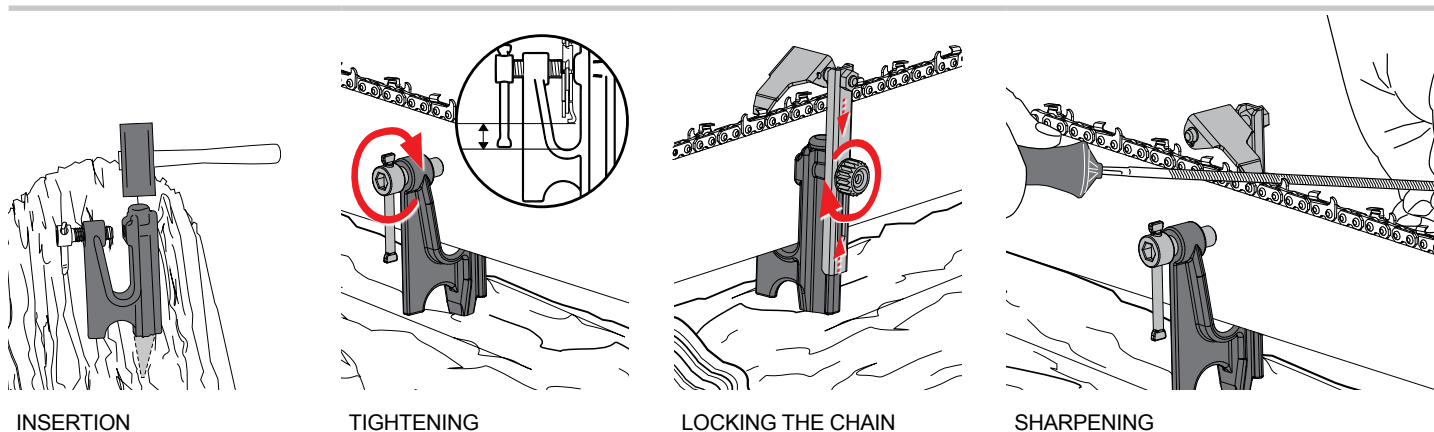



Filing Vise



Filing Vise for professional and hobby users. Usefull in the field.
Holds saw guide bar firmly when filing.

P/N	DESCRIPTION	EAN13 CODE
10909000	Filing Vise - CLAMSHELL	8032706102889

PACKAGING:		Q.TY x MASTER PACK:	25 pcs	
1 pc x Clamshell		MASTER CARTON:	42x26x16 cm	
		TOTAL WEIGHT:	10 kg	

ORDER MULTIPLES OF: 25 pcs

P/N	DESCRIPTION
1090900	Filing Vise - BULK

PACKAGING:	BULK	
Q.TY x MASTER PACK:	48 pcs	
MASTER CARTON:	24,5x24x12 cm	
TOTAL WEIGHT:	18,8 kg	

ORDER MULTIPLES OF: 48 pcs

► highlights

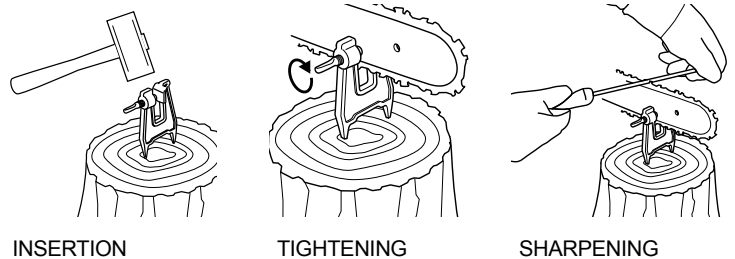

Magnetic Filing Angle Guide



Plastic item with 30°/35° angle marks on one side and 25°/35° angle on the other side; the 2 magnets keep it on the guide bar.

P/N	DESCRIPTION
1082901A	Filing guide 25°-30°
1082902	Filing guide 30°-35°

PACKAGING:	BULK	
Q.TY x MASTER PACK:	200 pcs	
MASTER CARTON:	44x26x28,5 cm	
TOTAL WEIGHT:	6 kg	

ORDER MULTIPLES OF: 200 pcs

Dept Gauge Jointers

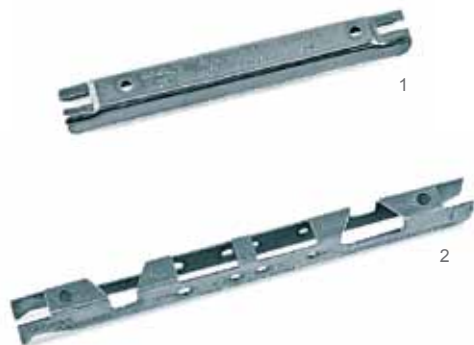

- 1 - For an accurate depth control setting.
- 2 - Can be used as bar groove cleaner, file angles and file gauge.

	P/N	DEPTH SETTING	
		mm	in
1	1018001	0,65 - 0,75	.025" - .030"
2	1018003	0,65 - 0,75 0,90 - 1,00	.025" - .030" .035" - .040"

PACKAGING: 50 pcs x Nylon Bag
 Q.TY x MASTER PACK: 50 pcs
 TOTAL WEIGHT: 1 → 2,3 kg
 2 → 2,8 kg



ORDER MULTIPLES OF: 50 pcs

Bar Groove Cleaner



This tool is useful for bar maintenance.
 Clears grooves and oil holes.

P/N	DESCRIPTION
1017001	Bar groove cleaner

PACKAGING: 300 pcs x Nylon Bag
 Q.TY x MASTER PACK: 300 pcs
 TOTAL WEIGHT: 3,8 kg



ORDER MULTIPLES OF: 300 pcs

Bar Dresser



Use



Tool for easily and quickly maintaining guide bar

P/N	DESCRIPTION
10829013	Saw bar dresser kit

PACKAGING: 1 kit x Plastic Box
 Q.TY x MASTER PACK: 20 pcs
 MASTER CARTON: 31x19x27 cm
 TOTAL WEIGHT: 4,2 kg



ORDER MULTIPLES OF: 20 pcs

Chain Saw Files



Regular use of the saw file increases efficiency, enhances confort, improves safety, reduces fuel consumption, wear and tear.

- Round file, smooth sharpening.
- Sharp edges, fine points.
- Made from chrome steel by **Vallorbe**.
- Hardness 66 HRC.

P/N	ROUND FILE Ø		FILE LENGTH	
	mm	in	mm	in
1010026	4,0	5/32"	200	8"
1011014	4,5	11/64"	200	8"
1011015	4,8	3/16"	200	8"
L00200000	5,2	13/64"	200	8"
1012009	5,5	7/32"	200	8"

PACKAGING: 12 pcs x Carton Box
 Q.TY x MASTER PACK: 300 pcs
 TOTAL WEIGHT: 8,5 kg

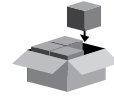

ORDER MULTIPLES OF: 300 pcs

Flat File Holders



Without handle and file

P/N	ROUND FILE Ø		FILE LENGTH	
	mm	in	mm	in
1010942	4,0	5/32"	200	8"
1019903	4,5	11/64"	200	8"
1011942	4,8	3/16"	200	8"
10139003	5,2	13/64"	200	8"
1012942	7/32"	5,5	8"	200

PACKAGING: BULK
 Q.TY x MASTER PACK: 100 pcs
 MASTER CARTON: 28x27x19 cm
 TOTAL WEIGHT: 10,4 kg



ORDER MULTIPLES OF: 100 pcs

File Handles



Comfortable plastic made file handles.
Fits round and flat files.

	P/N	DESCRIPTION
1	1013006	Red, with 30° and 35° filing angles
2	1013020	Black, professional

PACKAGING: BULK
 Q.TY x MASTER PACK: 1 → 250 pcs
 2 → 400 pcs
 MASTER CARTON: 1 → 24x24x24 cm
 2 → 41x37x29,5 cm
 TOTAL WEIGHT: 1 → 4,4 kg
 2 → 6,8 kg



ORDER MULTIPLES OF: 1 → 250 pcs
 2 → 400 pcs

Flat File Holders



Detail - 15° mark

For quick filing of any saw chain type and pitch. Complete slowing 25°/30° and 35° filing angle marks - 10° bent and for most accurate filing assembled with handle and file.

P/N	ROUND FILE Ø		FILE LENGTH	
	mm	in	mm	in
1010963	4,0	5/32"	215	8"
1019901	4,5	11/64"	200	8"
1011966	4,8	3/16"	200	8"
10139001	5,2	13/64"	200	8"
1012962	5,5	7/32"	200	8"

PACKAGING: BULK
 Q.TY x MASTER PACK: 50 pcs
 MASTER CARTON: 47,5x36,5x10,5 cm
 TOTAL WEIGHT: 6,3 kg



ORDER MULTIPLES OF: 50 pcs



Flat File Holders



Detail - 15° mark

For quick filing of any saw chain type and pitch. Complete slowing 25°/30° and 35° filing angle marks - 10° bent and for most accurate filing assembled with handle and file.

P/N	ROUND FILE Ø		FILE LENGTH		EAN13 CODE
	mm	in	mm	in	
10109002	4,0	5/32"	215	8"	8032706102834
10119002	4,8	3/16"	200	8"	8032706102841
10129002	5,5	7/32"	200	8"	8032706102858

PACKAGING:
1 pc x
Clamshell



Q.TY x MASTER PACK: 50 pcs
MASTER CARTON: 50x23x44,5 cm
TOTAL WEIGHT: 9 kg

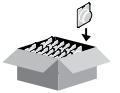

ORDER MULTIPLES OF: 50 pcs

Filing Kit



This kit for hand maintenance of saw chain, includes:

- one round file for chain top plate maintenance
- one flat file for depth gauge maintenance
- one depth gauge jointer
- two file handles

P/N	ROUND FILE Ø		FILE LENGTH		EAN13 CODE
	mm	in	mm	in	
10829004	4,0	5/32"	215	8"	8032706102599
10829007	4,5	11/64"	200	8"	8032706102810
10829005	4,8	3/16"	200	8"	8032706102605
10829008	5,2	13/64"	200	8"	8032706102827
10829006	5,5	7/32"	200	8"	8032706102612

PACKAGING:
1 kit x
Clamshell



Q.TY x MASTER PACK: 40 pcs
MASTER CARTON: 56x35,5x35 cm
TOTAL WEIGHT: 13 kg

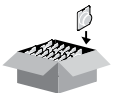

ORDER MULTIPLES OF: 40 pcs

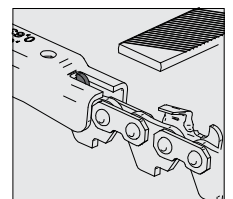
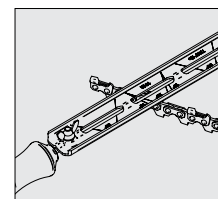

Steel Chain Breaker



PROFESSIONAL
USE



1/4" ÷ .404"
CHAIN PITCH



Bench type for workshop use, with operating lever for fast and easy chain breaking.

P/N	DESCRIPTION	CHAIN PITCH
1020961	Steel chain breaker	1/4" - .325" - 3/8" .404"

PACKAGING:

1 pc x
Carton Box



Q.TY x MASTER PACK: 10 pcs

MASTER CARTON: 56x35,3x28,5 cm

TOTAL WEIGHT: 33 kg

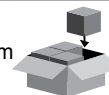

ORDER MULTIPLES OF: 10 pcs

► packaging



► provided with following items

ADJUSTABLE ANVIL

1 pc



PUNCH

1 pc 1.1 - .043" gauge chains



PUNCH (A)

1 pc 1/4" - 3/8" - .404" chains



WRENCH

1 pc HEX. 3 mm



Nudular Cast Iron Chain Breaker



PROFESSIONAL USE



ALL TYPE OF CHAIN



3/4" PITCH CHAINS



Sturdy construction achieved with high quality nodular cast iron. Suitable to all saw chains: from 1/4" to 3/4" pitch.

P/N	DESCRIPTION	CHAIN PITCH
1020980	Heavy duty chain breaker	1/4"-.325"- 3/8" .404"- 3/4"

PACKAGING: 1 pc x Carton Box
 Q.TY x MASTER PACK: 2 pcs
 MASTER CARTON: 39,5x30,5x11,5 cm
 TOTAL WEIGHT: 9,4 kg



ORDER MULTIPLES OF: 2 pcs

packaging



highlights



3/4" CHAIN PITCH

provided with following items

ADJUSTABLE ANVIL
1 pc



PUNCH
1 pc 1.1 - .043" gauge chains



PUNCH (A)
1 pc 1/4" - 3/8" - .404" chains



WRENCH
1 pc HEX. 3 mm



CHAIN ANVIL 3/4"
1 pc 3/4" chains



PUNCH 3/4"
1 pc 3/4" chains



Self Centering Vise



1/4" ÷ .404"
CHAIN PITCH



Press the knobs to open.
Spring return clamping for precise insertion
Quick and precise insertion of the chain in comparison with the traditional vises

P/N	DESCRIPTION	CHAIN PITCH
01020000	Adjustable anvil	1/4" - .325" - 3/8" .404"

PACKAGING: 10 pcs x Nylon Bag
Q.TY x MASTER PACK: 10 pcs
TOTAL WEIGHT: 1,2 kg



ORDER MULTIPLES OF: 10 pcs

► highlights

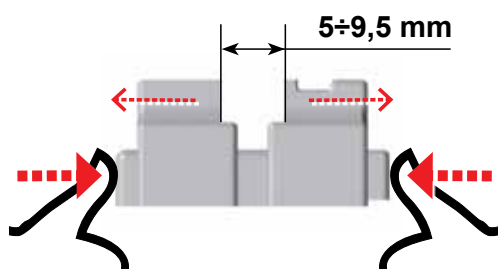

Relieved spring



Compressed spring

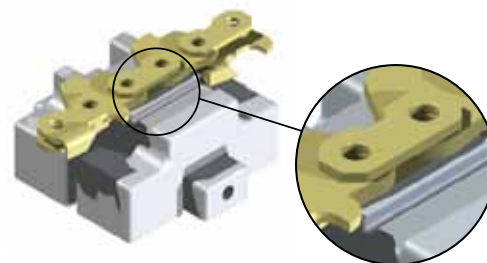

QUICK AND PRECISE INSERTION OF THE CHAIN

Press the knobs to open.
Spring return clamping for precise insertion

Adjustable Anvil



1/4" ± .404"
CHAIN PITCH

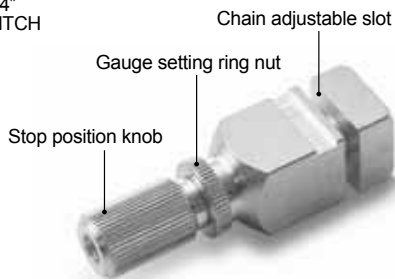

Adjustable chain anvil for chain breakers.

P/N	DESCRIPTION	CHAIN PITCH
1020070	Adjustable anvil	1/4" - .325" - 3/8" .404"

PACKAGING: 10 pcs x Nylon Bag
Q.TY x MASTER PACK: 10 pcs
TOTAL WEIGHT: 1,4 kg



ORDER MULTIPLES OF: 10 pcs

Slotted Anvil For Oregon Chains



1/4" ± .404"
CHAIN PITCH



The six slots ensures a perfect positioning for breaking most Oregon saw chain types.

P/N	DESCRIPTION	CHAIN PITCH
1020173	Slotted anvil	1/4" - .325" - 3/8" .404"

PACKAGING: 10 pcs x Nylon Bag
Q.TY x MASTER PACK: 10 pcs



ORDER MULTIPLES OF: 10 pcs

3/4" Pitch Chain Anvil



3/4" PITCH
CHAINS



Slotted anvil for 3/4" pitch chain.

P/N	DESCRIPTION	CHAIN PITCH
1020181	3/4" chain pitch anvil	3/4"

PACKAGING: 5 pcs x Nylon Bag
Q.TY x MASTER PACK: 5 pcs



ORDER MULTIPLES OF: 5 pcs

Punches



Punch for 0,50" (1,3 mm), 0,58" (1,5 mm), 0,63" (1,6 mm) gauge chains.

P/N	DESCRIPTION	CHAIN PITCH
1020033E	Punch (A)	1/4" - .325" - 3/8" - .404"

PACKAGING: 10 pcs x Nylon Bag
 Q.TY x MASTER PACK: 10 pcs
 TOTAL WEIGHT: 0,2 kg



ORDER MULTIPLES OF: 10 pcs



Punch for 1.1 mm (.043") gauge chains.

P/N	DESCRIPTION	CHAIN
1020189	Punch	1,1 - .043" gauge chains 3/8" Low Profile

PACKAGING: 10 pcs x Nylon Bag
 Q.TY x MASTER PACK: 10 pcs
 TOTAL WEIGHT: 0,2 kg



ORDER MULTIPLES OF: 10 pcs



3/4" PITCH CHAINS



Punch for 3/4" pitch chain.

P/N	DESCRIPTION	CHAIN PITCH
1020150	Punch	3/4"

PACKAGING: 5 pcs x Nylon Bag
 Q.TY x MASTER PACK: 5 pcs
 TOTAL WEIGHT: 0,2 kg



ORDER MULTIPLES OF: 5 pcs

Pocket Chain Breaker



Manual pocket chain breaker for chain repair in the field and in the shop, complete with plastic holster.

P/N	DESCRIPTION	CHAIN PITCH
1030900	Pocket chain breaker	.3/8" - .404" - 7/16" 1/2"

PACKAGING: 1 kit x Plastic Holster
 Q.TY x MASTER PACK: 15 pcs
 MASTER CARTON: 13,5x12x13 cm
 TOTAL WEIGHT: 3,8 kg



ORDER MULTIPLES OF: 15 pcs



Steel Rivet Spinner



PROFESSIONAL
USE



1/4" ÷ .404"
CHAIN PITCH



With built-in thrust bearing for minimum friction, giving fast and effortless spinning. Complete with take-up handle and spinner insert for .3/8" - .404" chains.

P/N	DESCRIPTION	CHAIN PITCH
1025950	Rivet spinner	1/4" - .325" - 3/8" .404"

PACKAGING: 1 pc x Carton Box		Q.TY x MASTER PACK: 10 pcs	
		MASTER CARTON: 59x31x39 cm	
		TOTAL WEIGHT: 21 kg	

ORDER MULTIPLES OF: 10 pcs

► packaging



► provided with following items

SPINNER INSERT (A)
1 pc for 3/8" - .404" chains



TAKE-UP HANDLE (A)
1 pc for 3/8" - .404" chains



Nudular Cast Iron Rivet Spinner



PROFESSIONAL USE



ALL TYPE OF CHAIN



3/4" PITCH CHAINS



Sturdy construction achive with high quality nodular cast iron. Easy 3/4" pitch chain riveting by means of thrust and needle bearings. Suitable for any kind of pitch chain.

P/N	DESCRIPTION	CHAIN PITCH
1025970	Heavy duty rivet spinner	1/4" - .325" - 3/8" .404" - 3/4"

PACKAGING: 1 pc x Carton Box
 Q.TY x MASTER PACK: 2 pcs
 MASTER CARTON: 39,5x30,5x11,5 cm
 TOTAL WEIGHT: 7,3 kg



ORDER MULTIPLES OF: 2 pcs

packaging



highlights



3/4" CHAIN PITCH

provided with following items

SPINNER INSERT (A)

1 pc for 3/8" - .404" chains



SPINNER INSERT (B)

1 pc for 1/4" - .325" chains



TAKE-UP HANDLE

1 pc for: 1/4" - .325" chains - (B)
 1 pc for: 3/8" - .404" chains - (A)



INSERT 3/4"

1 pc for 3/4" chains



THRUST BOLT 3/4"

1 pc for 3/4" chains



Take-up Handles



3/4" PITCH CHAINS

Take-up handle for RIVET SPINNER 1025950

P/N	DESCRIPTION	CHAIN PITCH
1 1026001D	Take-up handle (B)	1/4" - .325"
2 1027001D	Take-up handle (A)	3/8" - .404"

PACKAGING: BULK
Q.TY x MASTER PACK: 2 pcs



ORDER MULTIPLES OF: 2 pcs

Take-up handle for RIVET SPINNER 1025970

P/N	DESCRIPTION	CHAIN PITCH
1 1025091	Take-up handle (B)	1/4" - .325"
2 1025092	Take-up handle (A)	3/8" - .404"
3 1025106	Trust bolt - only for 1025970	3/4"

PACKAGING: BULK
1 → 2 pcs
Q.TY x MASTER PACK: 2 → 2 pcs
3 → 5 pcs



ORDER MULTIPLES OF: 1 → 2 pcs
2 → 2 pcs
3 → 5 pcs

Spinner Inserts



3/4" PITCH CHAINS

Spinner insert for RIVET SPINNER 1025950-1025970-11319000-11319001

P/N	DESCRIPTION	CHAIN PITCH
1 1028002D	Spinner insert (B)	1/4" - .325"
2 1029001E	Spinner insert (A)	3/8" - .404"
3 1025105	Insert - only for 1025970	3/4"

PACKAGING: BULK
1 → 10 pcs
Q.TY x MASTER PACK: 2 → 10 pcs
3 → 5 pcs



ORDER MULTIPLES OF: 1 → 10 pcs
2 → 10 pcs
3 → 5 pcs

Chain Repair Master

Rivet Spinner & Chain Breaker



PROFESSIONAL
USE



1/4" ÷ .404"
CHAIN PITCH

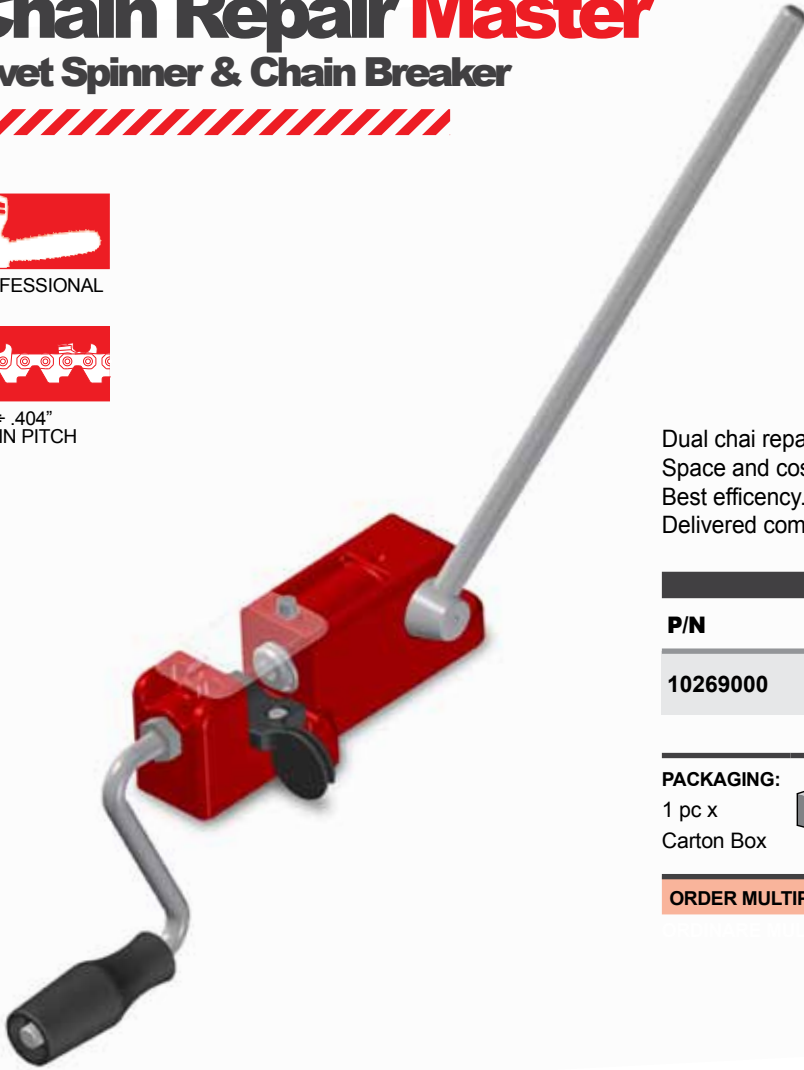

Dual chain repair tool.
Space and cost saving.
Best efficiency.
Delivered complete with dedicated tools for every working configurations.

P/N	DESCRIPTION	CHAIN PITCH
10269000	Manual Rivet spinner / Chain breaker	1/4" - .325" - 3/8" .404"
PACKAGING: 1 pc x Carton Box		Q.TY x MASTER PACK: 6 pcs
		TOTAL WEIGHT: 20 kg
ORDER MULTIPLES OF: 6 pcs		

packaging



Neutral box

provided with following items



SPINNER INSERT

1 pc for 1/4" - .325" chains
1 pc for 3/8" - .404" chains



PRESSING TOOL

1 pc for 1/4" - .325" chains
1 pc for 3/8" - .404" chains



PUNCH

1 pc for 1/4" - .325" chains
1 pc for 3/8" - .404" chains



CHAIN ANVIL

1 pc for 1/4" chains
1 pc for .325" chains
1 pc for 3/8" chains
1 pc for .404 chains
1 pc for 91 chains



WRENCHES

1 pc HEX. 3 mm
1 pc HEX. 4 mm

Chain Repair Master

► accessories to be ordered separately for 3/4" chain

P/N K00112002

3/4" Rivet spinner & Chain Breaker kit

- 1 pc insert 3/4"
- 1 pc pressing tool 3/4"
- 1 pc punch 3/4"
- 1 pc chain anvil 3/4"



PACKAGING: Nylon Bag



ORDER MULTIPLES OF: 1 pc

Chain Repair Master

► highlights

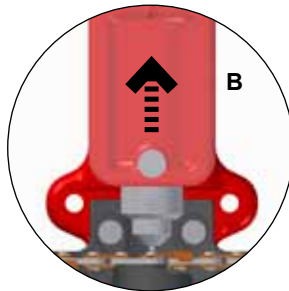
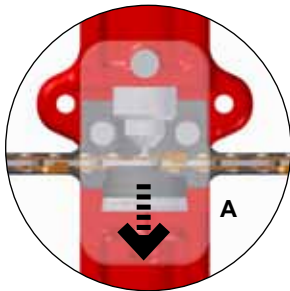

A – Protection shield, working configuration
B – Protection shield, chain setting configuration.

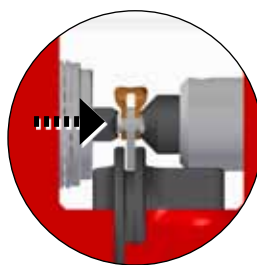
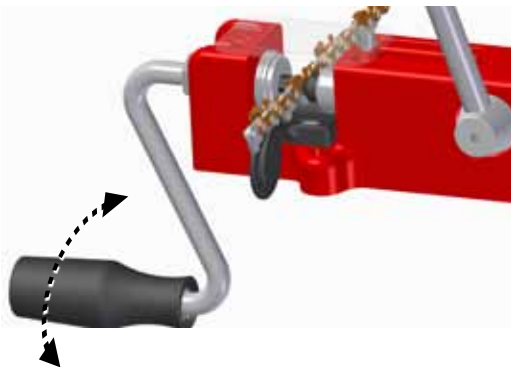

RIVETING

Chain riveting lever ensures stress reduction to minimum. Only one arm in rotation.

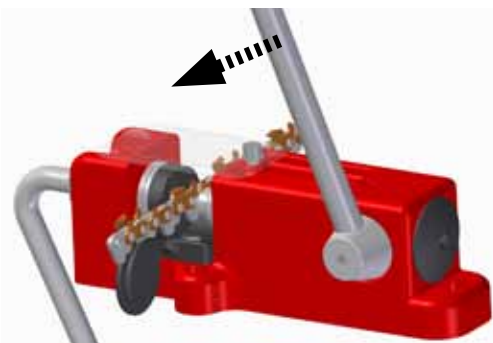

BREAKING

Better and ergonomics during chain breaking due to horizontal direction of the tool movement. Complete view of the chain breaking area.

EASYRivet

Electric Rivet Spinner



- Compact Electric Rivet Spinner.
- Low speed, precise riveting, no rivet burning.
- Easy to install at any workshop.
- High torque gearmotor to repair chains up to .404" pitch.
- Cast iron body.



► plugs

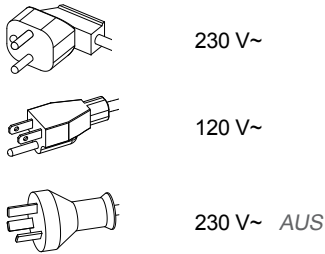

P/N	VOLTAGE		RATED POWER W	MAX SPEED min ⁻¹	CHAIN PITCH	EAN13 CODE
	V~	Hz				
11319000	230	50	85	160	1/4"	8032706103800
11319001	120	60	85	160	.325" 3/8"	8032706103800
AUS 11319005	230	50	85	160	.404"	8032706103800

► certifications



PACKAGING: 1 pc x Carton Box
 Q.TY x MASTER PACK: 1 pc
 MASTER CARTON: 37x15x24,5 cm
 TOTAL WEIGHT: 8,0 kg



ORDER MULTIPLES OF: 1 pc

► packaging



► provided with following items

KIT SPINNROLL INSERT
 1 kit for 1/4" - .325" chains



KIT SPINNROLL INSERT
 1 kit for 3/8" - .404" chains



► highlights

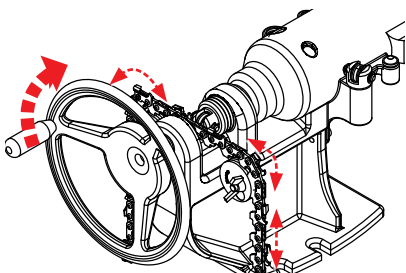

EFFORTS REDUCTION
 Efforts reduction for professional user.

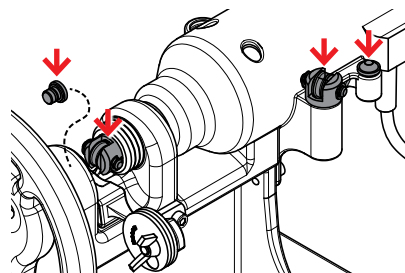

FULL EQUIPPED
 Equipped with full series of spinnroll inserts and spinner tools

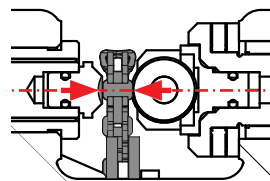

PRECISE RESULT
 Precise and consistent results in heavy duty conditions.

Piston Stop



P/N DESCRIPTION

1	1111007	Universal nylon piston stop - 2 strokes
2	01111001	Universal nylon piston stop - 2 strokes / 4 strokes

PACKAGING: 10 pcs x Nylon Bag
 Q.TY x MASTER PACK: 50 pcs
 TOTAL WEIGHT: 0,6 kg



ORDER MULTIPLES OF: 10 pcs

P/N DESCRIPTION

1	1111003	Nylon piston stop - 2 strokes
2	01111002	Nylon piston stop - 2 strokes / 4 strokes

PACKAGING: 10 pcs x Nylon Bag
 Q.TY x MASTER PACK: 50 pcs
 TOTAL WEIGHT: 1,0 kg



ORDER MULTIPLES OF: 10 pcs

P/N DESCRIPTION

1	1111008	Metal piston stop - 2 strokes
2	01111003	Metal piston stop - 2 strokes / 4 strokes

PACKAGING: 10 pcs x Nylon Bag
 Q.TY x MASTER PACK: 50 pcs
 TOTAL WEIGHT: 5,5 kg



ORDER MULTIPLES OF: 10 pcs

Piston Ring Clamp Set



Useful for assembling pistons and cylinders. 4 size of clamps.

P/N DESCRIPTION

01111000	Piston ring clam set - 2 strokes / 4 strokes
-----------------	--

PACKAGING: 1 set x Plastic Holster
 Q.TY x MASTER PACK: 50 pcs
 MASTER CARTON: 41x25x15 cm
 TOTAL WEIGHT: 3,6 kg



ORDER MULTIPLES OF: 50 pcs

Pressure Gauge



Gauge for carburetor and cylinder testing.

P/N	DESCRIPTION
1043900	Pressure gauge
PACKAGING:	1 pc x Carton Box
Q.TY x MASTER PACK:	1 pc
MASTER CARTON:	22x12x5,5 cm
TOTAL WEIGHT:	0,2 kg
ORDER MULTIPLES OF: 1 pc	



Pressure Gauge Kit



Professional carburetor service kit, with pressure gauge, special tools and punches.

P/N	DESCRIPTION
1081900	Pressure gauge kit
PACKAGING:	1 pc x Plastic Box
Q.TY x MASTER PACK:	1 pc
TOTAL WEIGHT:	0,6 kg
ORDER MULTIPLES OF: 1 pc	



Bar Guards



For safety purposes and to protect the saw bar and chain.

P/N	LENGTH	
	mm	in
1144033	300 x 91	12" x 3 9/16"
1144038	350 x 91	14" x 3 9/16"
1144156	400 x 91	16" x 3 9/16"
1144043	400 x 120	16" x 4 3/4"
1144048	450 x 120	18" x 4 3/4"
1144053	500 x 120	20" x 4 3/4"
PACKAGING:	BULK	
Q.TY x MASTER PACK:	48 pcs	
MASTER CARTON:	51,5x38x30 cm	
TOTAL WEIGHT:	6,8 kg	
ORDER MULTIPLES OF: 48 pcs		



Grease Gun



DISLAY 25 PCS



Handy plastic gun for sprocket tip guide bars; refillable plunger type.

P/N	DESCRIPTION	PACKAGING
1108001	GREASE GUN	Carton Display
PACKAGING:		Carton Display
Q.TY x PACK DISPLAY:		25 pcs
PACK DISPLAY:		16x14x16 cm 
TOTAL WEIGHT:		0,9 kg
ORDER MULTIPLES OF: 25 pc		

P/N	DESCRIPTION	PACKAGING
01108000	GREASE GUN	Bulk
PACKAGING:		BULK
Q.TY x CARTON:		800 pcs
MASTER CARTON:		62,5x40x55 cm 
TOTAL WEIGHT:		25 kg
ORDER MULTIPLES OF: 800 pcs		

Oil and Grease Gun



Oil and grease gun for chain saw, specially designed for sprocket bar tip. Metal tip, diam. 35 mm; polypropylene body. Capacity: 100 gr.

P/N	DESCRIPTION	
1108025	Grease gun	
PACKAGING:		BULK
Q.TY x PACK DISPLAY:		25 pcs
TOTAL WEIGHT:		2 kg 
ORDER MULTIPLES OF: 25 pc		

Wedges



Tough plastic; durable and safe felling and bucking without damaging the chain.
 Double tapered new line of bucking and falling wedges.
 Rough surface for more anti kick-back safety and higher lifting force

Type



A



B

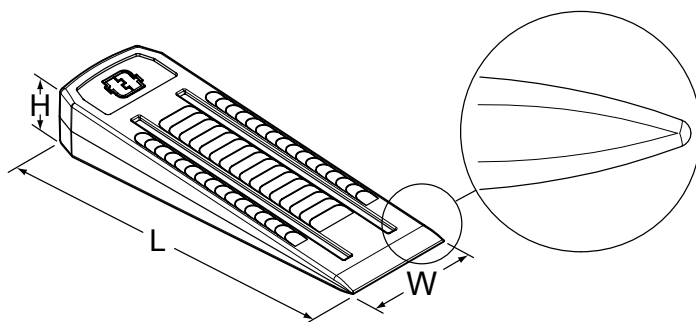

P/N	TYPE	DIMENSIONS			WEIGHT	EAN13 CODE			
		L	W	H					
		mm	in	mm	in	kg			
01055003	A	183	7,205"	64,5	2,539"	24	0,945"	0,16 kg	8032706106016

PACKAGING: BULK
 Q.TY x MASTER PACK: 46 pcs
 MASTER CARTON: 30,5x21x24 cm
 TOTAL WEIGHT: 7,4 kg



ORDER MULTIPLES OF: 46 pcs



P/N	TYPE	DIMENSIONS			WEIGHT	EAN13 CODE			
		L	W	H					
		mm	in	mm	in	kg			
01055004	B	231	9,095"	70	2,756"	30	1,181"	0,26 kg	8032706106023

PACKAGING: BULK
 Q.TY x MASTER PACK: 42 pcs
 MASTER CARTON: 23x23x23 cm
 TOTAL WEIGHT: 11,4 kg



ORDER MULTIPLES OF: 42 pcs



P/N	TYPE	DIMENSIONS			WEIGHT	EAN13 CODE			
		L	W	H					
		mm	in	mm	in	kg			
01055005	A	243	9,567"	73	2,874"	39,3	1,547"	0,40 kg	8032706106030

PACKAGING: BULK
 Q.TY x MASTER PACK: 36 pcs
 MASTER CARTON: 41x25x15 cm
 TOTAL WEIGHT: 15,0 kg



ORDER MULTIPLES OF: 36 pcs



Wedges



Tough plastic; durable and safe felling and bucking without damaging the chain.

Type

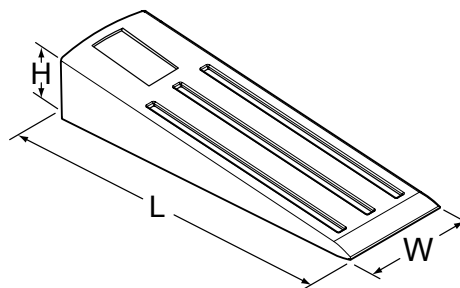

P/N	DIMENSIONS		
	L mm	W mm	H mm
1055903A	140	70	27

PACKAGING: BULK
 Q.TY x MASTER PACK: 25 pcs
 MASTER CARTON: 15x15x21 cm
 TOTAL WEIGHT: 3,5 kg



ORDER MULTIPLES OF: 25 pcs



P/N	DIMENSIONS		
	L mm	W mm	H mm
1055901A	190	70	26

PACKAGING: BULK
 Q.TY x MASTER PACK: 25 pcs
 MASTER CARTON: 36x20x11 cm
 TOTAL WEIGHT: 5,5 kg



ORDER MULTIPLES OF: 25 pcs



P/N	DIMENSIONS		
	L mm	W mm	H mm
1055904A	265	77	29

PACKAGING: BULK
 Q.TY x MASTER PACK: 25 pcs
 MASTER CARTON: 42x26x16 cm
 TOTAL WEIGHT: 10 kg



ORDER MULTIPLES OF: 25 pcs

Wedges



Tough plastic; durable and safe felling and bucking without damaging the chain.
 Double tapered new line of bucking and falling wedges.
 Rough surface for more anti kick-back safety and higher lifting force

Type



A

B

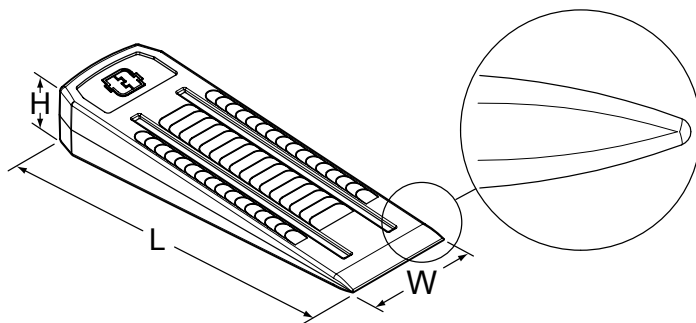

P/N	TYPE	DIMENSIONS			WEIGHT	EAN13 CODE				
		L	W	H						
		mm	in	mm	in	kg				
1	01055000	A	183	7,205"	64,5	2,539"	24	0,945"	0,20	8032706104029
2	01055001	B	231	9,095"	70	2,756"	30	1,181"	0,35	8032706104036
3	01055002	A	243	9,567"	73	2,874"	39,3	1,547"	0,50	8032706104043

PACKAGING:
 1 pc x
 Clamshell



Q.TY x MASTER PACK: 24 pcs
 MASTER CARTON: 43x25x27,5 cm
 TOTAL WEIGHT: **1** → 3,8 kg
2 → 6,4 kg
3 → 9,7 kg

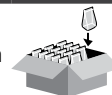

ORDER MULTIPLES OF: 24 pcs

Lawnmower Blade Balancer



Improved version for any kind of lawnmower blade.
6 magnets allow higher stability.



P/N	DESCRIPTION
0580000	Lawnmower blade balancer

PACKAGING: 1 pc x Carton Box
 Q.TY x MASTER PACK: 1 pc
 MASTER CARTON: 18x16,5x12 cm
 TOTAL WEIGHT: 1,3 kg



ORDER MULTIPLES OF: 1 pc

Use



SPARE PARTS

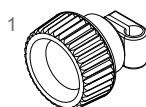

P/N	DESCRIPTION	ORDER MULTIPLES OF:
1 K00112000	Plastic clamp	1 pc

highlights

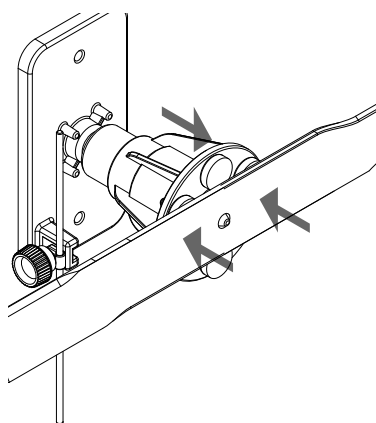

POSITIONING
Fit the blade onto the pivot.
6 magnets, with their greater surface, ensure a perfect grip.

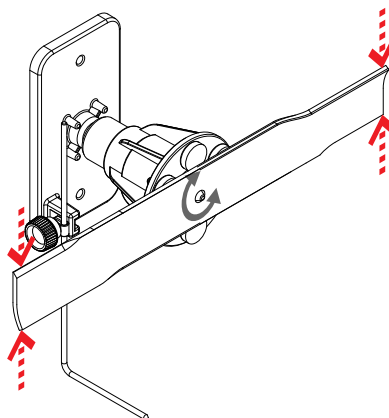

BALANCE
To check the balance, position the blade horizontally and release it and visually check the position that it takes on.

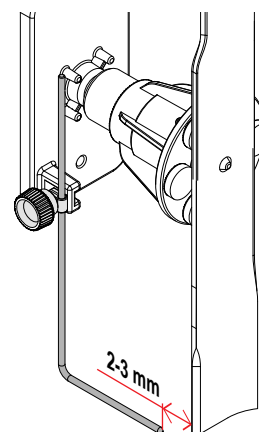

CUTTING EDGES ALIGNMENT
Check the alignment (planarity) of the cutting edges, rotate the blade by 180° and visually quantify any differing distances of the edge

Manual Set Gauge



Manual set gauge, for correct chisel blade gauge setting.



P/N	DESCRIPTION	BLADE THICKNESS		EAN13 CODE
		mm	in	
10829011	Set gauge	1,6 ÷ 2,0	.06" ÷ .08"	8032706105019

PACKAGING:
1 pc x
Clamshell



Q.TY x MASTER PACK: 24 pcs
MASTER CARTON: 46x35x17 cm
TOTAL WEIGHT: 8 kg

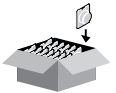

ORDER MULTIPLES OF: 24 pcs

► Packaging



► highlights



SUITABLE TO MOST COMMON STEEL BLADES

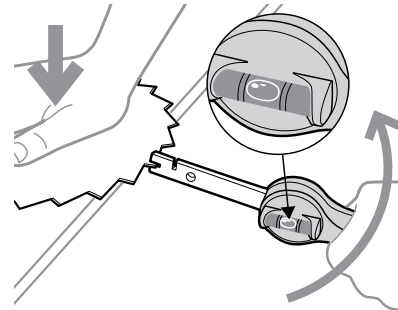
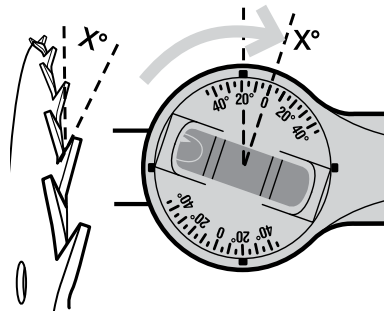
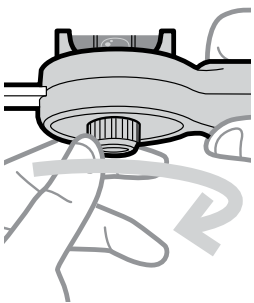

EASY TO SET END USE

AUTO-FILL STOP

self-closing filler



Safety filler spout to prevent fuel leakage.

- Recommended to fill tanks of small petrol engines.
- Easy to fit on Tecomec cans.
- Also fits most of the popular fuel cans available on the market.

P/N	DESCRIPTION	EAN13 CODE
51709005	Self-closing spout	8032706103558

► suitable for use on:

Tecomec dual-purpose cans



P/N 5170901



P/N 5170903



P/N 51709008

PACKAGING:

1 pc x
Hanger
Nylon Bag



Q.TY x MASTER PACK:

MASTER PACK:

TOTAL WEIGHT:

MAX Q.TY x CARTON

MASTER CARTON:

TOTAL WEIGHT:

20 pcs

33,5x21x28 cm

3 kg

160 pcs

71x43x60 cm

25,5 kg

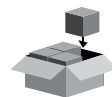

ORDER MULTIPLES OF: 20 pcs

► highlights

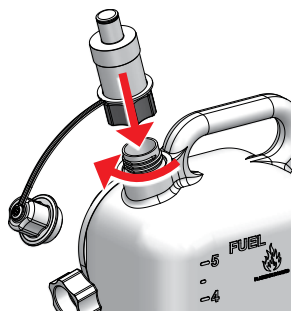

Easy to fit on Tecomec dual-purpose cans.

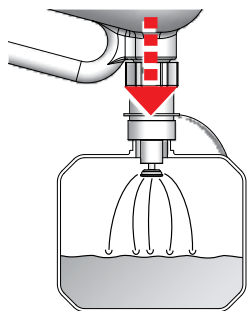

ON / OFF liquid flow to the full tank.

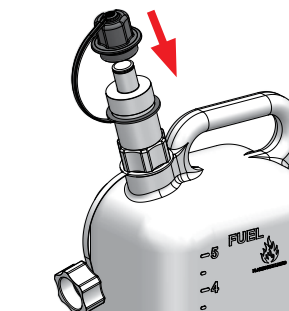
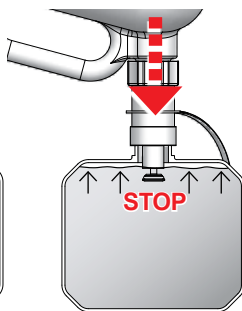

Complete with cap for protection and to prevent dirt.

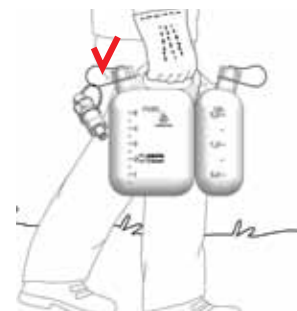

Transport.

Funnel Assy Filter



1



2



3

P/N	DESCRIPTION	ORDER MULTIPLES OF:
1 5175901	Funnel assy - small	24 pcs
2 5175902	Funnel assy - medium	24 pcs
3 5175001	Funnel filter	10 pcs

PACKAGING:

1-2 → Carton Box

3 → Nylon Bag

Q.TY x MASTER PACK:

1-2 → 24 pcs

3 → 10 pcs

MASTER CARTON:

1-2 → 42,5x28,5x36,5 cm

1-2

3



Plastic Cans

SPOUT
NOT INCLUDED



Double use plastic can, red.

P/N	DESCRIPTION
-----	-------------

51709008	Can 3,5 L + 1,5 L
----------	-------------------

PACKAGING:	Nylon Wrap
Q.TY x MASTER PACK:	24 pcs
NYLON WRAP:	67x56x25 cm
TOTAL WEIGHT:	12,5 kg
MAX Q.TY x PALLET:	216 pcs
TOTAL WEIGHT:	132,5 kg

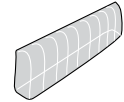

ORDER MULTIPLES OF: 24 pcs

► accessories to be ordered separately

P/N K00404003

Complete spout with cap.
L=125 mm



PACKAGING:	Nylon Bag
Q.TY x MASTER PACK:	4 pcs



ORDER MULTIPLES OF: 4 pcs

► highlights



OPTIONAL SPOUT L=125mm
Spout not included



TRANSPORT



COMBINATION WRENCH'S SLOT
Wrench not included

Plastic Cans



SPOUT INCLUDED

1



SPOUT INCLUDED

2

Double use plastic can, red.
High quality, light and resistant. Professional type.

P/N	DESCRIPTION	COLOR	EAN13 CODE
1 5170901	Can L 5 + 2,5 Professional type	Red	8032706101790
2 5170903	Can L 5 + 2,5 Professional type	White	8032706101806

PACKAGING: Carton Box
Q.TY x MASTER PACK: 4 pcs
MASTER CARTON: 35x38x38 cm
TOTAL WEIGHT: 4,2 kg



MAX Q.TY x PALLET: 144 pcs
TOTAL WEIGHT: 172,0 kg



ORDER MULTIPLES OF: 4 pcs

certifications



SPARE PARTS



1

2

P/N	DESCRIPTION	ORDER MULTIPLES OF:
1 5170001	COMPLETE SPOUT	4 pcs
2 5170003	COMPLETE CAP	4 pcs

PACKAGING:
Nylon Bag



Double Use Plastic Can 6+3



Double use plastic can, red.
 High quality, light and resistant. Professional type.
 Capacity: fuel 6 L / oil 3 L.
 Provided with two easy fill spouts: one for fuel and one for oil
 System specially designed to ensure a fast filling, with automatic stop of the liquid when the tank is full.

P/N	DESCRIPTION	COLOR
51709011	Can L 6 + 3 Professional type	Red
51709012	Can L 6 + 3 Professional type	White

PACKAGING: Nylon Wrap
 Q.TY x MASTER PACK: 16 pcs
 NYLON WRAP: 80x120x34 cm
 TOTAL WEIGHT: 15,5 kg

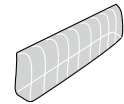

MAX Q.TY x PALLET: 96 pcs
 DIMENSIONS: 80x120x207 cm
 TOTAL WEIGHT: 113 kg



ORDER MULTIPLES OF: 16 pcs

certifications



provided with following items



1 pc FUEL spout - green



1 pc OIL spout - red

SPARE PARTS



P/N	DESCRIPTION	ORDER MULTIPLES OF:
1 51709009	COMPLETE EASY FILL SPOUT - FUEL	4 pcs
2 51709010	COMPLETE EASY FILL SPOUT - OIL	4 pcs
3 51709014	COMPLETE CAP	4 pcs

PACKAGING: Nylon Bag



Double Use Plastic Can 6+3

► highlights



TWO EASY FILL SPOUTS INCLUDED
One for fuel and one for oil.

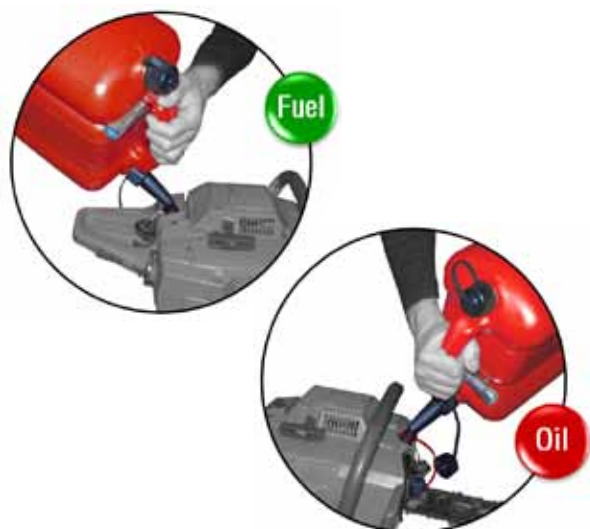

FUEL / OIL FILLING
Automatic stop of the liquid when the tank is full



FIT TWO COMBINATION WRENCHES IN THE RELEVANT SLOTS.
Wrenches not included

CHAIN SAW ACCESSORIES SPARE PARTS



SUPERJolly electric chain grinder 120 V - 230 V

► SPARE PARTS

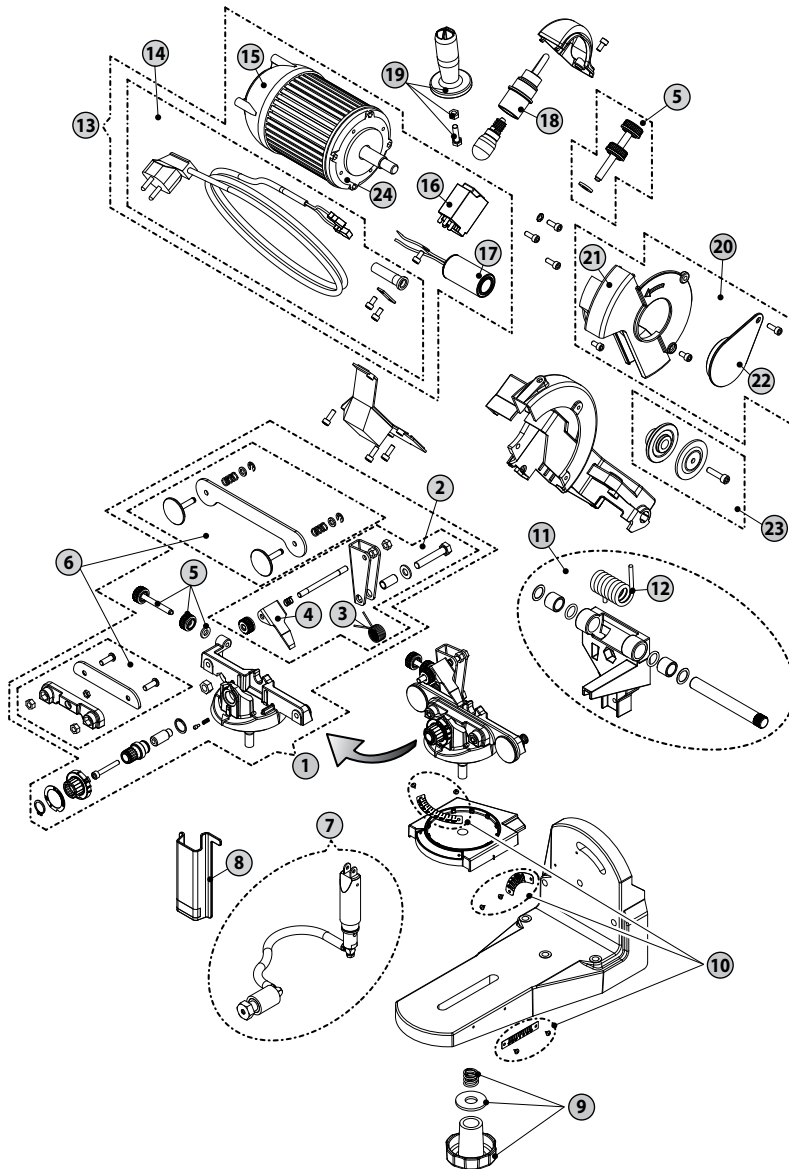

P/N	DESCRIPTION	ORDER MULTIPLES OF:
1	K00200336 Complete vise assembly	1 pc
2	K00200334 Chain hold kit	1 pc
3	K00200352 Chain stop spring	10 pcs
4	K00200323 Chain stop	5 pcs
5	K00200357 Adjustment knobs, kit	1 pc
6	K00200339 Vise jaws, vise assy	1 pc
7	K00200319 Complete hydraulic a.bly	1 pc
8	K00200338 Cylinder protection	1 pc
9	K00200342 Vise locking kit	1 pc
10	K00200333 Scales Kit	1 pc
11	K00200337 Bracket, arm support	1 pc
12	K00200335 Spring, arm return	5 pcs
13	K00200340 Complete electrical a.bly 120V~	1 pc
	K00200341 Complete electrical a.bly 230V~	1 pc
14	K00200145 Cable kit complete with plug - 120V~	1 pc
	K00200160 Cable kit complete with plug - 230V~	1 pc
	K00200161 Cable kit complete with plug-230V~ CH	1 pc
	K00200162 Cable kit complete with plug-230V~ AUS	1 pc
15	K00200155 End motor bell	1 pc
16	K00200151 Switch - 120V~	1 pc
	K00200157 Switch - 230V~	1 pc
17	K00200152 Capacitor 8 Micro-Farad - 120V~	1 pc
	K00200158 Capacitor 8 Micro-Farad - 230V~	1 pc
18	K00200146 Light socket E12 w/wires - 120V~	1 pc
	1135264 Light socket E14 w/wires - 230V~	1 pc
19	K00200147 Handle kit	1 pc
20	K00200185 Shield wheel protector	1 pc
21	K00200343 Metal shield	1 pc
	1155134 Shield kit	1 pc
22	K00200355 Motor flange kit (outer and inner)	1 pc
23	K00200144 Motor 120V~	1 pc
	K00200159 Motor 230V~	1 pc

PACKAGING:
Nylon Bag



CHAIN SAW ACCESSORIES SPARE PARTS



SUPERJOLLY

electric chain grinder 120 V - 230 V (OLD VERSION)

SPARE PARTS

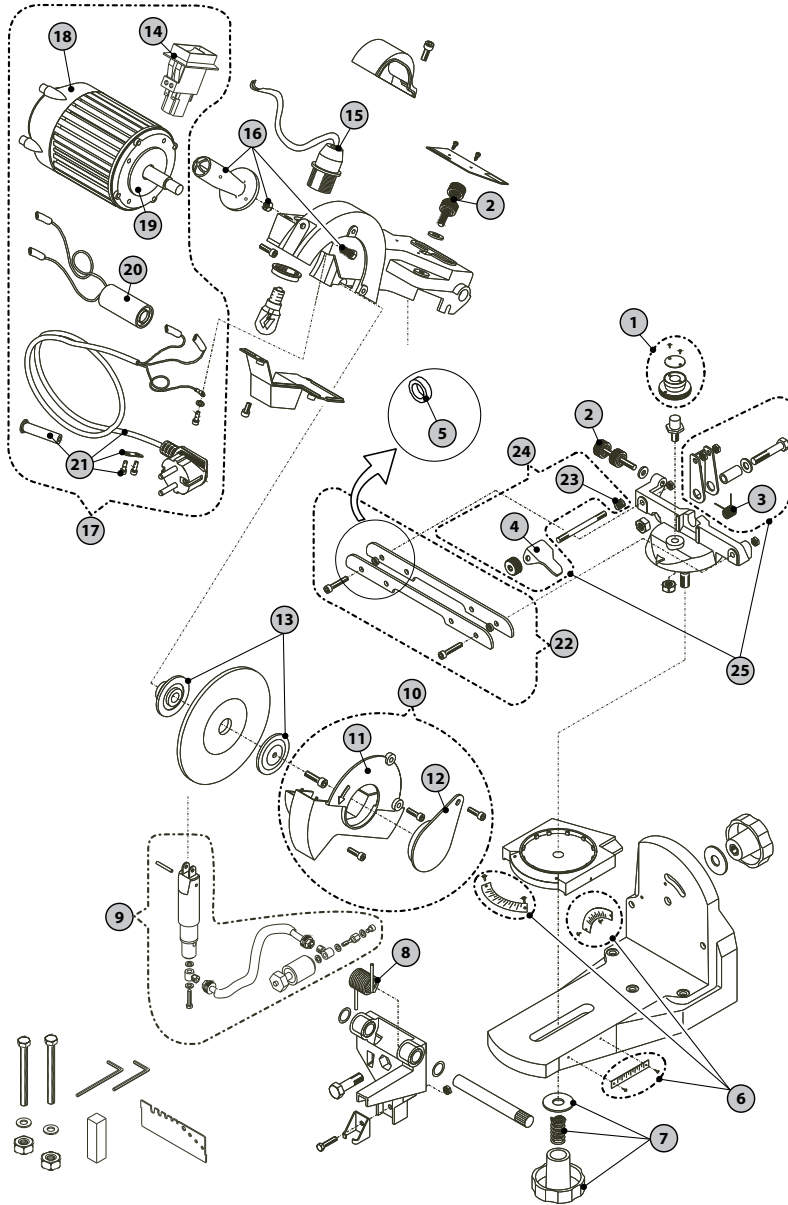

P/N	DESCRIPTION	ORDER MULTIPLES OF:
1	K00200359 Adj. cam vise position	1 pc
2	K00200357 Adjustment knobs, kit	1 pc
3	K00200352 Chain stop spring	1 pc
4	K00200350 Chain stop	5 pcs
5	K00200353 Chain vise spacers	10 pcs
6	K00200333 Scales kit	1 pc
7	K00200342 Vise locking kit	1 pc
8	K00200360 Motor mount arm spring	1 pc
9	1150088 Complete hydraulik a.bly	1 pc
10	K00200185 Shield wheel protector	1 pc
11	K00200343 Metal shield	1 pc
12	1155134 Shield kit	1 pc
13	K00200355 Motor flange kit (outer and inner)	1 pc
14	K00200151 Switch - 120V~	1 pc
	K00200157 Switch - 230V~	1 pc
15	K00200146 Light socket E12 w/wires - 120V~	1 pc
	1135264 Light socket E14 w/wires - 230V~	1 pc
16	K00200147 Handle kit	1 pc
17	K00200340 Complete electrical a.bly 120V~	1 pc
	K00200341 Complete electrical a.bly 230V~	1 pc
18	K00200155 End motor bell	1 pc
19	K00200144 Motor 120V~	1 pc
	K00200159 Motor 230V~	1 pc
20	K00200152 Capacitor 8 Micro-Farad - 120V~	1 pc
	K00200158 Capacitor 8 Micro-Farad - 230V~	1 pc
21	K00200145 Cable kit complete with plug - 120V~	1 pc
	K00200160 Cable kit complete with plug - 230V~	1 pc
	K00200161 Cable kit complete with plug-230V~ CH	1 pc
	K00200162 Cable kit complete with plug-230V~ AUS	1 pc
22	K00200196 Vise jaws kit	1 pc
23	K00200351 Pawl center spring kit	5 pcs
24	K00200193 Chain stop, vise assy	1 pc
25	K00200356 Chain hold kit	1 pc

PACKAGING:
Nylon Bag



CHAIN SAW ACCESSORIES SPARE PARTS



JOLLYStar

electric chain grinder 120 V - 230 V

▶ SPARE PARTS

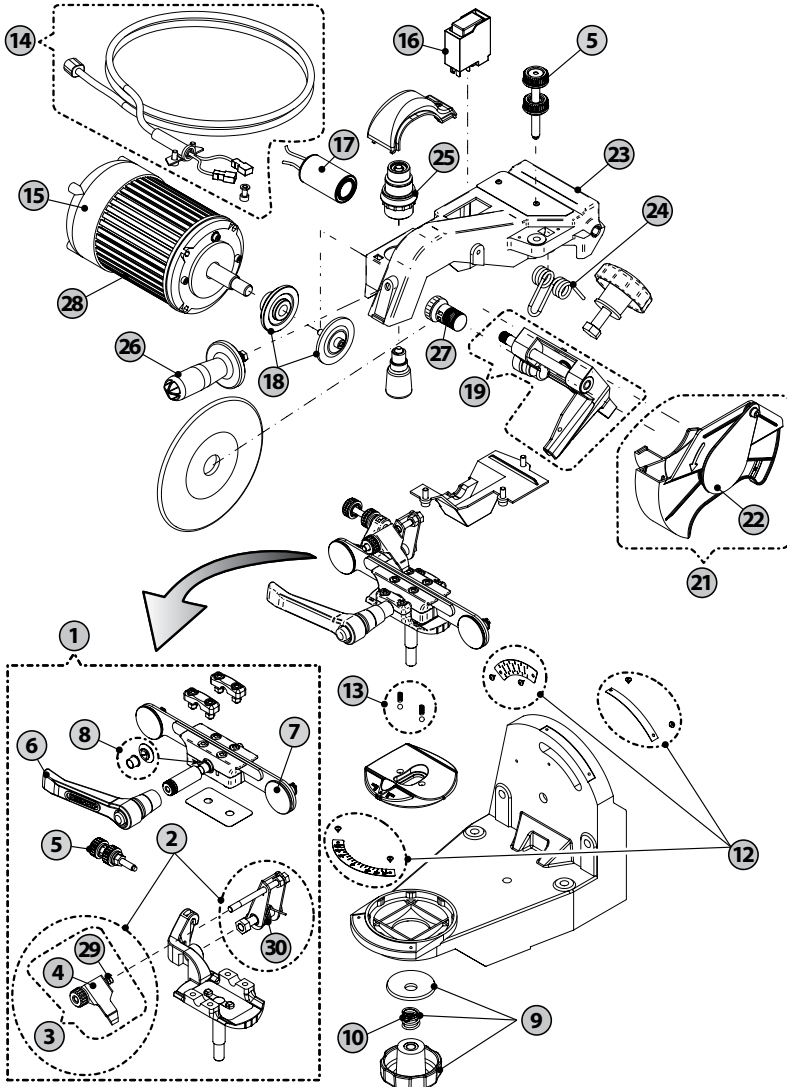

P/N	DESCRIPTION	ORDER MULTIPLES OF:
1	K00200169 Complete vise assembly	1 pc
2	K00200356 Chain hold kit	1 pc
3	K00200193 Chain stop, vise assy	1 pc
4	K00200350 Chain stop	5 pcs
5	K00200357 Adjustment knobs, kit	1 pc
6	K00200141 Lever, vise assy chain locking	1 pc
7	K00200175 Vise jaws, vise assy	1 pc
8	K00200176 Vise bushing, vise assy	1 pc
9	K00200342 Vise locking kit	1 pc
10	K00200180 Spring	10 pcs
12	K00200333 Scales Kit	1 pc
13	K00200179 Spring and ball kit	1 pc
14	K00200145 Cable kit complete with plug - 120V~	1 pc
	K00200160 Cable kit complete with plug - 230V~	1 pc
	K00200161 Cable kit complete with plug-230V~ CH	1 pc
	K00200162 Cable kit complete with plug-230V~ AUS	1 pc
15	K00200155 End motor bell	1 pc
16	K00200151 Switch - 120V~	1 pc
	K00200157 Switch - 230V~	1 pc
17	K00200152 Capacitor 8 Micro-Farad - 120V~	1 pc
	K00200158 Capacitor 8 Micro-Farad - 230V~	1 pc
18	K00200355 Motor flange kit (outer and inner)	1 pc
19	K00200184 Bracket, arm support	1 pc
21	K00200139 Shield wheel protector	1 pc
22	K00200140 Shield kit	1 pc
23	K00200136 Arm, complete	1 pc
24	K00200154 Spring, arm return	5 pcs
25	K00200146 Light socket E12 w/wires - 120V~	1 pc
	1135264 Light socket E14 w/wires - 230V~	1 pc
26	K00200147 Handle kit	1 pc
27	K00200149 Safety pin	5 pcs
28	K00200144 E-Motor - 120V~	1 pc
	K00200159 E-Motor - 230V~	1 pc
29	K00200351 Spring	5 pcs
30	K00200352 Spring	10 pcs

PACKAGING:
Nylon Bag



CHAIN SAW ACCESSORIES SPARE PARTS



COMPACT electric chain grinder 120 V - 230 V

► SPARE PARTS

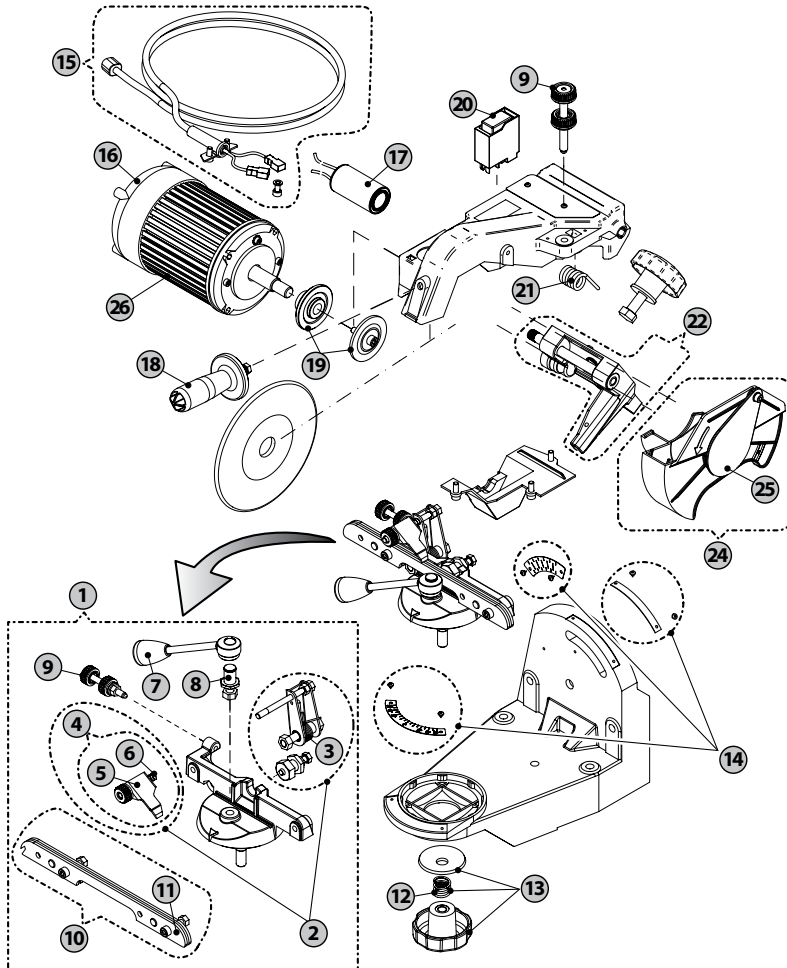

P/N	DESCRIPTION	ORDER MULTIPLES OF:
1	K00200203 Complete vise assembly	1 pc
2	K00200356 Chain hold kit	1 pc
3	K00200352 Spring	10 pcs
4	K00200193 Chain stop, vise assy	1 pc
5	K00200350 Chain stop	5 pcs
6	K00200351 Spring	5 pcs
7	K00200197 vise handle	1 pc
8	K00200199 cam post	1 pc
9	K00200357 Adjustment knobs, kit	1 pc
10	K00200196 vise jaws	1 pc
11	K00200353 chain vise spacers	10 pcs
12	K00200180 Spring	10 pcs
13	K00200342 Vise locking kit	1 pc
14	K00200333 Scales Kit	1 pc
15	K00200145 Cable kit complete with plug - 120V~	1 pc
	K00200160 Cable kit complete with plug - 230V~	1 pc
	K00200161 Cable kit complete with plug-230V~ CH	1 pc
	K00200162 Cable kit complete with plug-230V~ AUS	1 pc
16	K00200155 End motor bell	1 pc
17	K00200152 Capacitor 8 Micro-Farad - 120V~	1 pc
	K00200158 Capacitor 8 Micro-Farad - 230V~	1 pc
18	K00200147 Handle kit	1 pc
19	K00200355 Motor flange kit (outer and inner)	1 pc
20	K00200151 Switch - 120V~	1 pc
	K00200157 Switch - 230V~	1 pc
21	K00200201 Spring, arm return	50 pcs
22	K00200184 Bracket, arm support	1 pc
24	K00200195 Shield wheel protector	1 pc
25	K00200140 Shield kit	1 pc
26	K00200144 E-Motor - 120V~	1 pc
	K00200159 E-Motor - 230V~	1 pc

PACKAGING:
Nylon Bag



CHAIN SAW ACCESSORIES SPARE PARTS



JOLLY electric chain grinder 120 V - 230 V

► SPARE PARTS

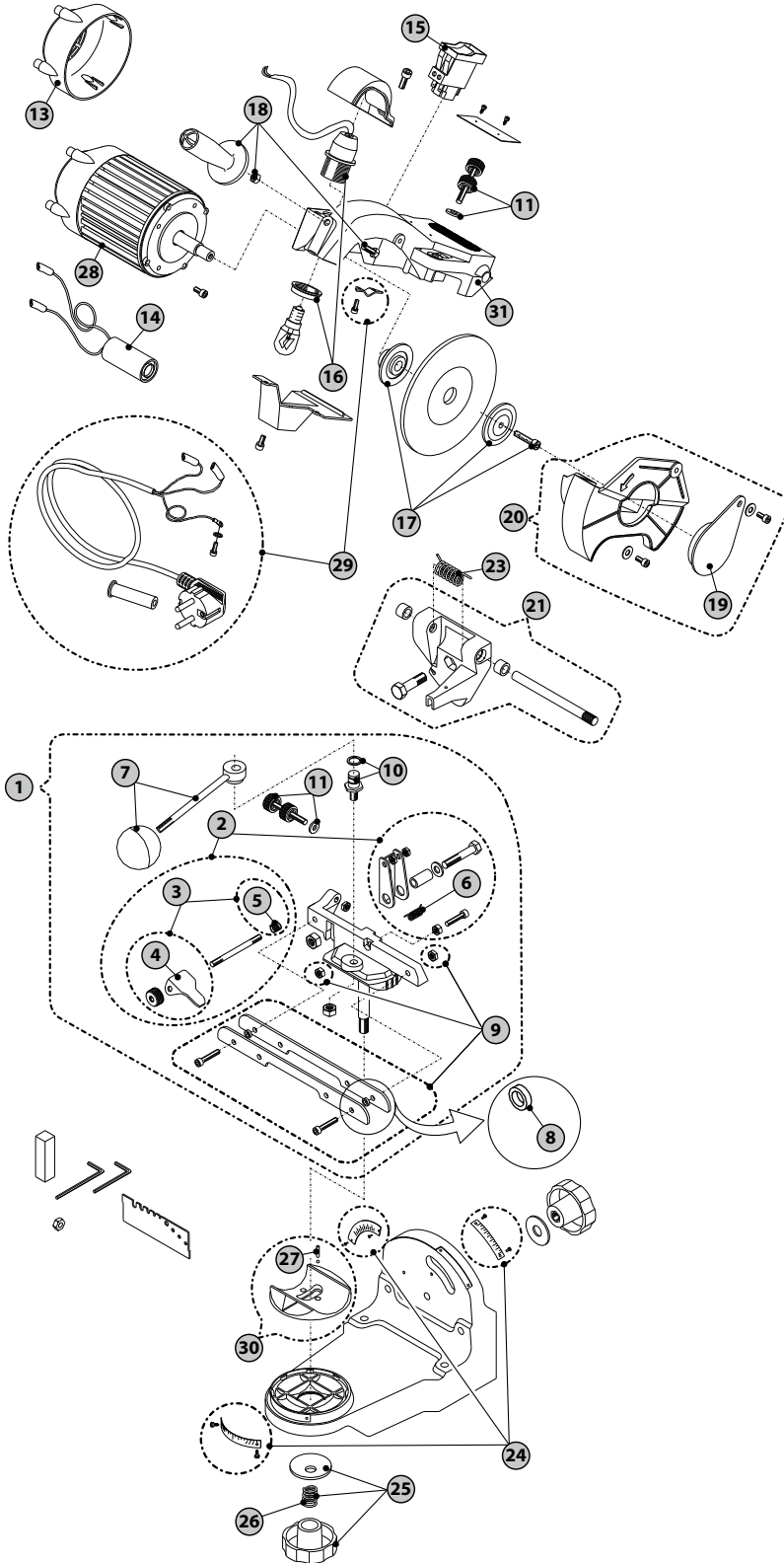

P/N	DESCRIPTION	ORDER MULTIPLES OF:
1	1135026 Complete vise assembly	1 pc
2	K00200356 Chain hold kit	1 pc
3	K00200193 Chain stop, vise assy	1 pc
4	K00200350 Chain stop	5 pcs
5	K00200351 Pawl center spring kit	5 pcs
6	K00200352 Chain stop spring	10 pcs
7	K00200197 Vise handle	1 pc
8	K00200353 Chain vise spacers	10 pcs
9	K00200196 Vise jaws	1 pc
10	K00200199 Cam post	1 pc
11	K00200357 Adjustment knobs, kit	1 pc
13	K00200155 End motor cap	1 pc
14	K00200152 Capacitor 8mF 120V~	1 pc
	K00200158 Capacitor 230V~	1 pc
15	K00200151 Switch 120V~	1 pc
	K00200157 Switch 230V~	1 pc
16	K00200146 Light socket E12 w/wires - 120V~	1 pc
	1135264 Light socket E14 w/wires - 230V~	1 pc
17	K00200355 Motor flange kit (outer and inner)	1 pc
18	K00200147 Handle kit	1 pc
19	K00200140 Shield kit	1 pc
20	K00200139 Shield wheel protector	1 pc
21	K00200184 Bracket, arm support	1 pc
23	K00200201 Spring	50 pcs
24	K00200333 Scales kit	1 pc
25	K00200342 Vise locking kit	1 pc
26	K00200180 Spring	10 pcs
27	K00200179 Spring and ball kit	1 pc
28	K00200144 E-Motor 120V~	1 pc
	K00200159 E-Motor 230V~	1 pc
29	K00200145 Cable kit complete with plug - 120V~	1 pc
	K00200160 Cable kit complete with plug - 230V~	1 pc
	K00200162 Cable kit complete with plug-230V~ CH	1 pc
	K00200161 Cable kit complete with plug-230V~ AUS	1 pc
30	1135212 Flange and nut	1 pc

PACKAGING:
Nylon Bag



CHAIN SAW ACCESSORIES SPARE PARTS



MIDI Jolly electric chain grinder 120 V - 230 V

► SPARE PARTS

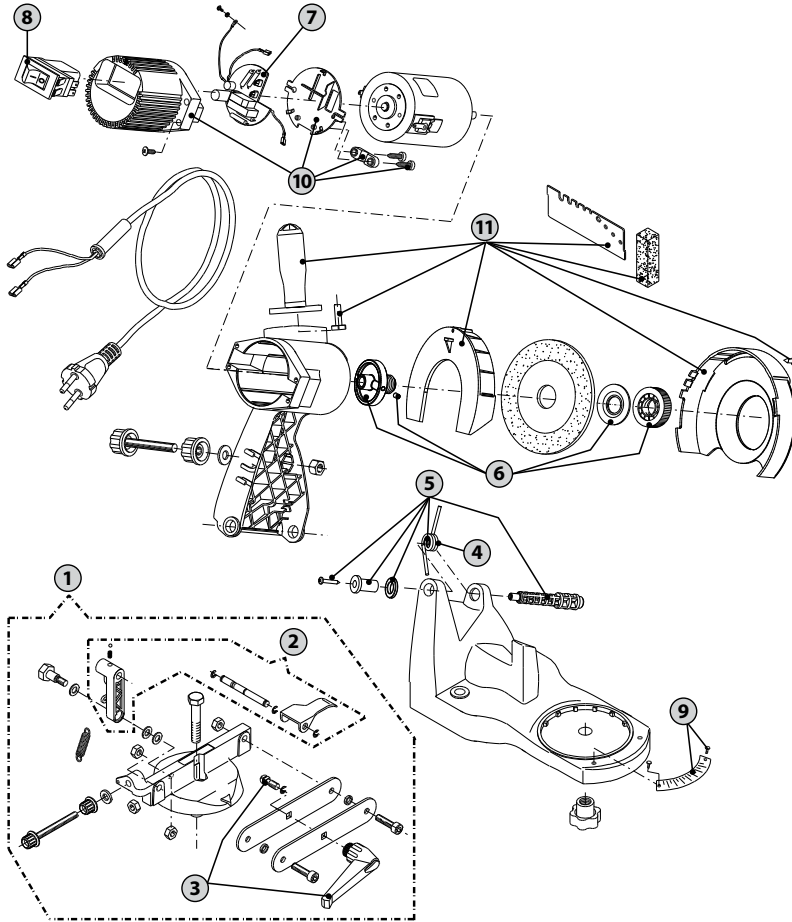

P/N	DESCRIPTION	ORDER MULTIPLES OF:
1	1190014 Complete vise	1 pc
2	K00200361 Chain stop retrofit kit	1 pc
3	K00200362 Vise position/tension adjustment knob	1 pc
4	1185123 Return spring, grind lever	1 pc
5	K00200304 Spring arm return set	1 pc
6	1190046 Aluminium arbor retrofit kit	1 pc
7	1190107 120V-230V electric cardboard	1 pc
8	K00200157 230V switch	1 pc
	K00500048 120V switch	1 pc
9	1190050 Vise screws and plate kit	1 pc
10	1190128 Cover and holding plate kit	1 pc
11	K00200358 Equipment kit	1 pc

PACKAGING:
Nylon Bag



CHAIN SAW ACCESSORIES SPARE PARTS



EASYGrinder electric chain grinder 120 V - 230 V

▶ SPARE PARTS

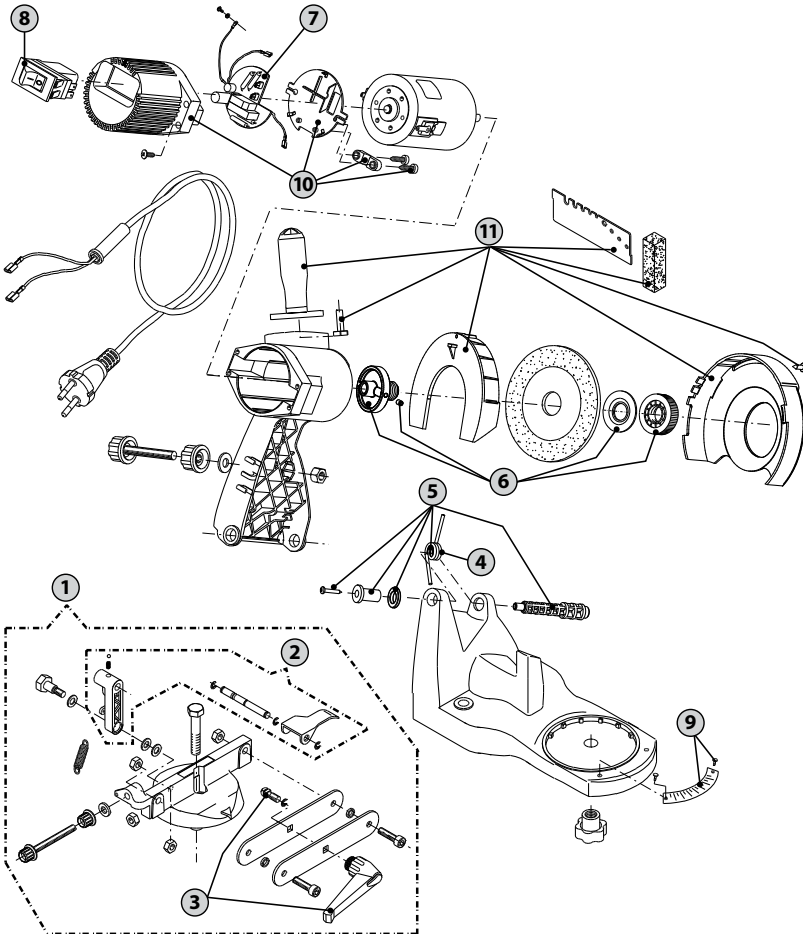

P/N	DESCRIPTION	ORDER MULTIPLES OF:
1	1190014 Complete vise	1 pc
2	K00200361 Chain stop retrofit kit	1 pc
3	K00200362 Vise position/tension adjustment knob	1 pc
4	1185123 Return spring, grind lever	1 pc
5	K00200304 Spring arm return set	1 pc
6	1190046 Aluminium arbor retrofit kit	1 pc
7	1190107 120V-230V electric cardboard	1 pc
8	K00200157 230V switch	1 pc
	K00500048 120V switch	1 pc
9	1190050 Vise screws and plate kit	1 pc
10	1190128 Cover and holding plate kit	1 pc
11	K00200358 Equipment kit	1 pc

PACKAGING:
Nylon Bag



CHAIN SAW ACCESSORIES SPARE PARTS



SHARPBoy electric chain grinder 120 V - 230 V

► SPARE PARTS

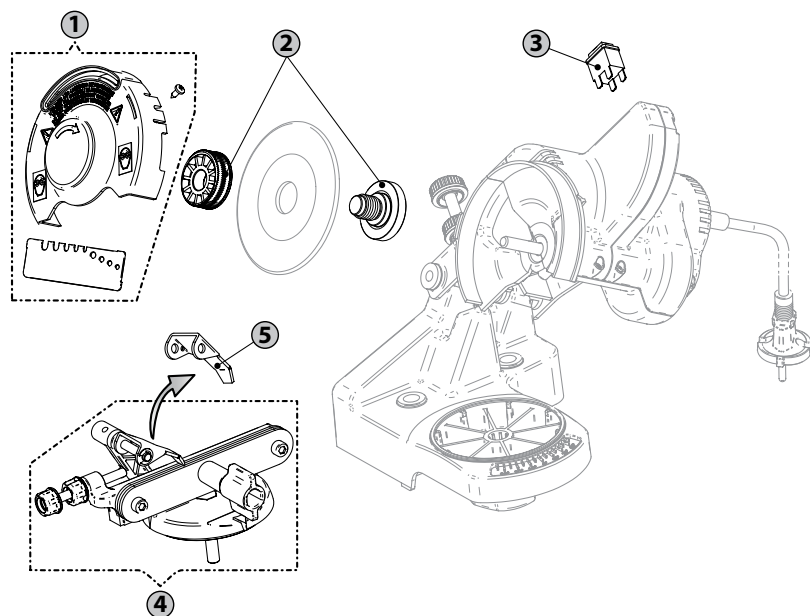

P/N	DESCRIPTION	ORDER MULTIPLES OF:
1	B01102004 Shield wheel protector	1 pc
2	K00200132 Motor flange kit (outer and inner)	1 pc
3	I00500002 Switch 120V - 230V	1 pc
4	1190014 Vise assembly	1 pc
5	K00200350 Chain stop	5 pcs

PACKAGING:
Nylon Bag



CHAIN SAW ACCESSORIES SPARE PARTS



BABY Jolly

electric chain grinder 120 V - 230 V

► SPARE PARTS

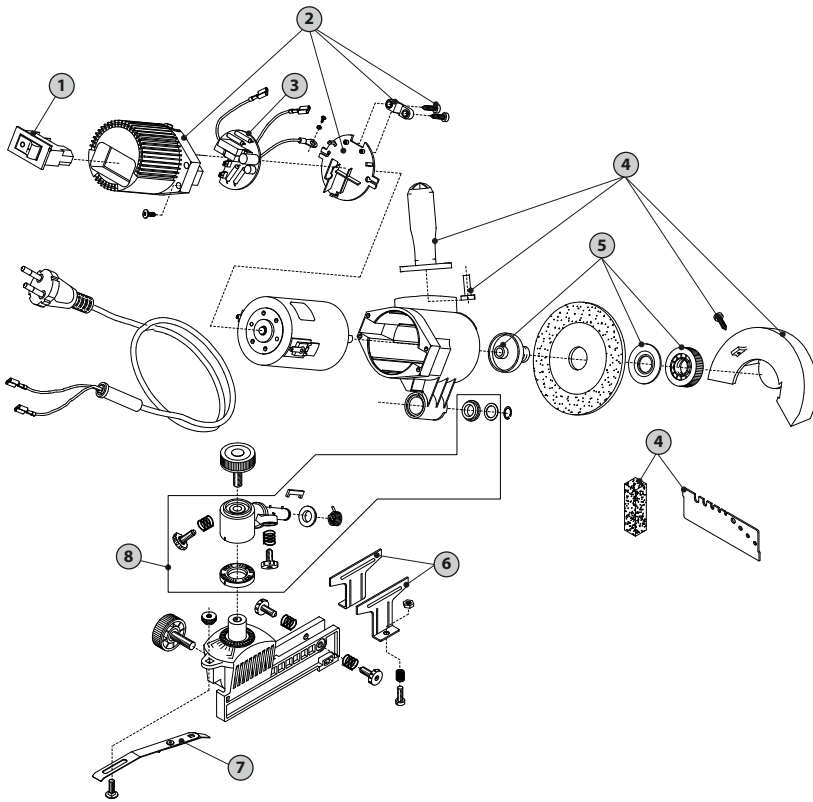

P/N	DESCRIPTION	ORDER MULTIPLES OF:
1 1150185	230V switch	1 pc
1190115	120V switch	1 pc
2 1190128	Cover and holding plate kit	1 pc
3 1190107	120V / 230V electric cardboard	1 pc
4 K00200358	Equipment kit	1 pc
5 1190046	Aluminium arbor retrofit kit	1 pc
6 1147075	Jaw	1 pc
7 1195060	Chain stop pawl	1 pc
8 1195015	Complete head kit	1 pc

PACKAGING:
Nylon Bag



BABY Jolly

electric chain grinder 12 V

► SPARE PARTS

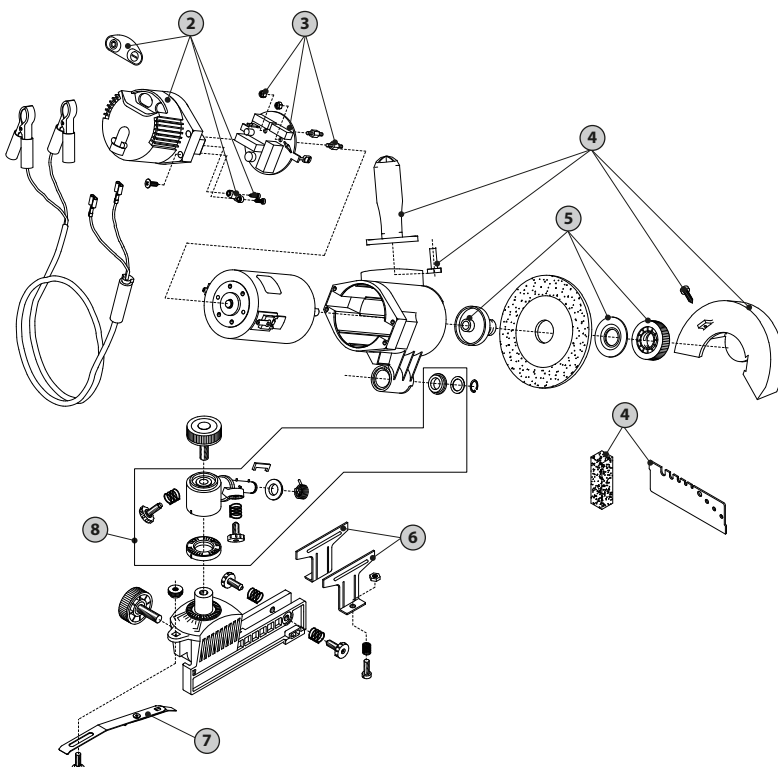

P/N	DESCRIPTION	ORDER MULTIPLES OF:
2 1195064	Cover and secure the cable	1 pc
3 1195104	12V electric cardboard	1 pc
4 K00200358	Equipment kit	1 pc
5 1190046	Aluminium arbor retrofit kit	1 pc
6 1147075	Jaw	1 pc
7 1195060	Chain stop pawl	1 pc
8 1195015	Complete head kit	1 pc

PACKAGING:
Nylon Bag



CHAIN SAW ACCESSORIES SPARE PARTS



Steel Chain Breaker

► SPARE PARTS

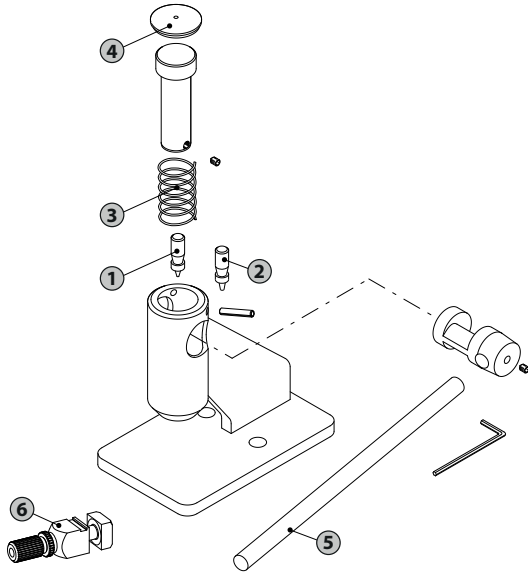

P/N	DESCRIPTION	ORDER MULTIPLES OF:
1 1020033E	Standard Punch (A)	10 pcs
2 1020189	Punch .043"	10 pcs
3 1020011	Spring	1 pc
4 1020012	Cap	1 pc
5 1020028	Handle	1 pc
6 1020070	Adjustable chain anvil	10 pcs

PACKAGING:
Nylon Bag



Nudular Cast Iron Chain Breaker

► SPARE PARTS

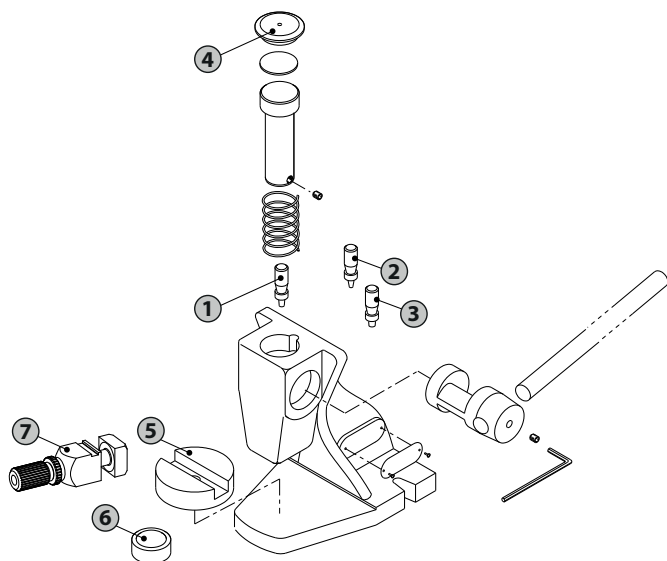

P/N	DESCRIPTION	ORDER MULTIPLES OF:
1 1020033E	Standard Punch (A)	10 pcs
2 1020189	Punch .043"	10 pcs
3 1020150	Punch 3/4"	5 pcs
4 1020012	Cap	1 pc
5 1020181	Breaker anvil, harv. Nose	5 pcs
6 1020209	Anvil for chain br. 109570	1 pc
7 1020070	Adjustable chain anvil	10 pcs

PACKAGING:
Nylon Bag





Steel Rivet Spinner

► SPARE PARTS

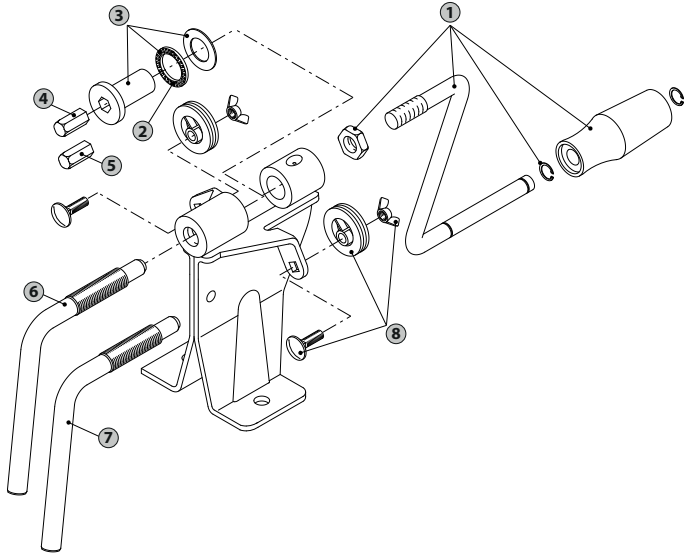

P/N	DESCRIPTION	ORDER MULTIPLES OF:
1 1025057	Spinner handle with grip	1 pc
2 3036017	Thrust bearing	5 pcs
3 K00500074	Sleeve	1 pc
4 1029001E	Spinner anvil (A)	10 pcs
5 1028002D	Spinner anvil (B)	10 pcs
6 1027001D	Take-up handle (A)	2 pcs
7 1026001D	Take-up handle (B)	2 pcs
8 1025066	Chain support disc.+bolt+nut	1 pc

PACKAGING:
Nylon Bag



Nudular Cast Iron Rivet Spinner



► SPARE PARTS

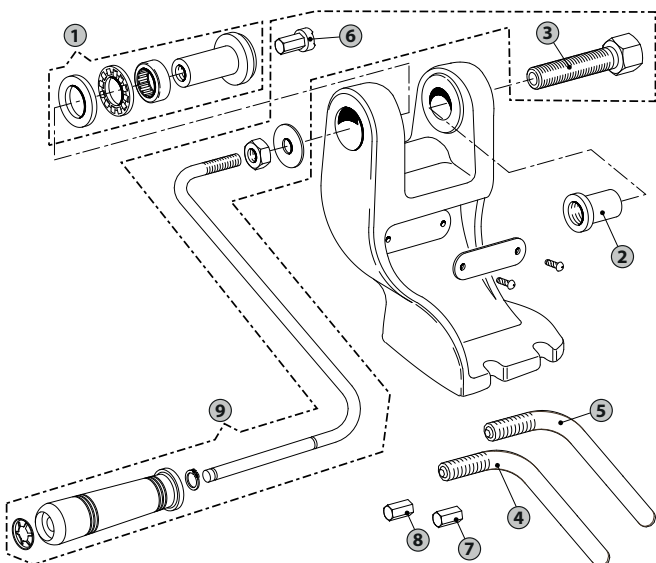

P/N	DESCRIPTION	ORDER MULTIPLES OF:
1 K00500073	Anvil drive bushing	1 pc
2 1025093	Threaded bushing	1 pc
3 1025106	Take-up bolt hex-end	5 pcs
4 1025092	Take up handle (A)	2 pcs
5 1025091	Take up handle (B)	2 pcs
6 1025105	3/4 pitch spinner anvil	5 pcs
7 1029001E	Spinner anvil (A)	10 pcs
8 1028002D	Spinner anvil (B)	10 pcs
9 1025143	3/4 pitch adapter kit	1 pc

PACKAGING:
Nylon Bag



CHAIN SAW ACCESSORIES SPARE PARTS



Chain Repair **Master** rivet spinner & chain breaker

► SPARE PARTS

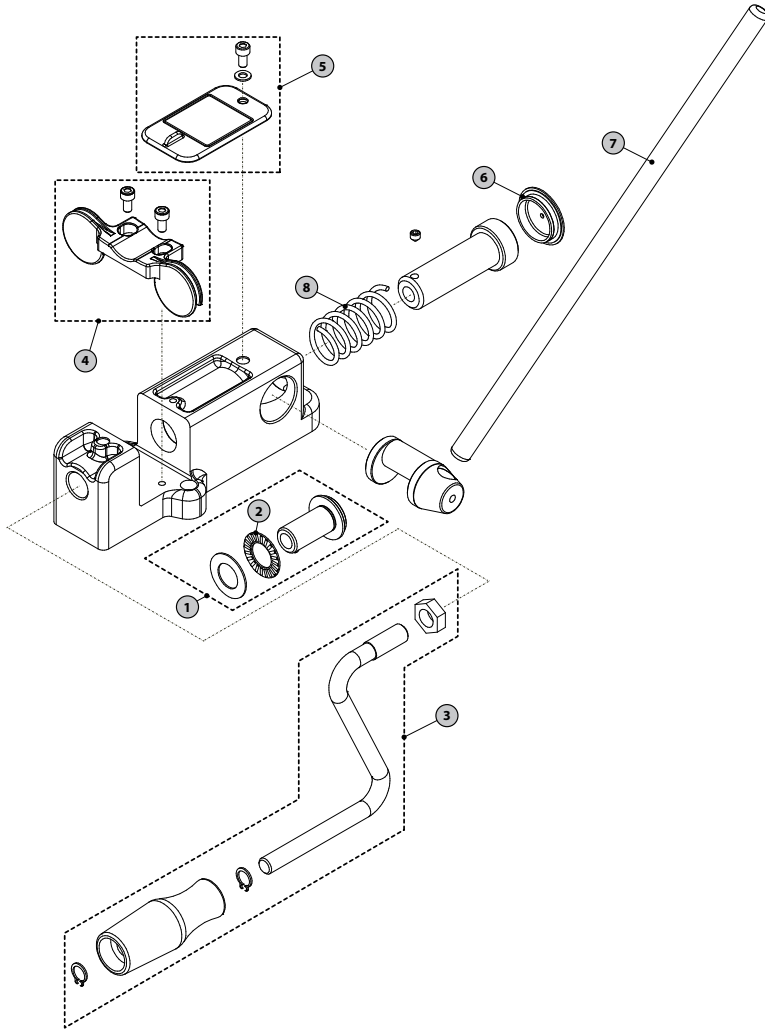

P/N	DESCRIPTION	ORDER MULTIPLES OF:
1 K00500074	Sleeve	1 pc
2 3036017	Thrust bearing	1 pc
3 1025057	Spinner handle with grip	1 pc
4 K00500087	Chain guide	1 pc
5 K00500088	Eye protetor	1 pc
6 1020012	Cap	1 pc
7 K00500089	Handle	1 pc
8 1020011	Spring	1 pc

PACKAGING:
Nylon Bag



CHAIN SAW ACCESSORIES SPARE PARTS



EASYRIVET

electric rivet spinner 120 V - 230 V

► SPARE PARTS

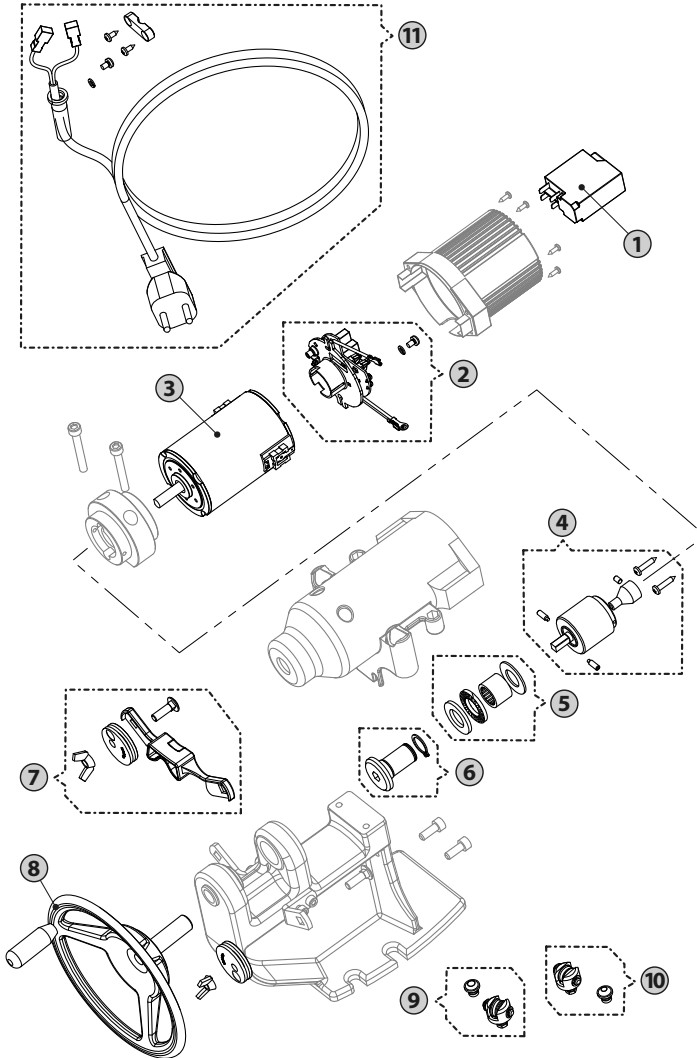

P/N	DESCRIPTION	ORDER MULTIPLES OF:
1	K00500048 Switch 120V~	1 pc
	K00200157 Switch 230V~	1 pc
2	K00500050 120V/230V electric cardboard	1 pc
3	K00500052 E-motor 120V~	1 pc
	K00500051 E-motor 230V~	1 pc
4	K00500044 Planetary gear kit	1 pc
5	K00500053 Bearing kit	1 pc
6	K00500045 Bush kit	1 pc
7	K00500059 Chain guide unit	1 pc
8	K00500058 Handle wheel	1 pc
9	K00500057 Kit spinnroll insert (1/4" - .325")	1 pc
10	K00500056 Kit spinnroll insert (3/8" - .404")	1 pc
11	K00500049 E-Cable kit 120V	1 pc
	K00500046 E-Cable kit 230V	1 pc

PACKAGING:
Nylon Bag



CHAIN SAW ACCESSORIES SPARE PARTS



RIVETMASTER

electric rivet spinner 120 V - 230 V

► SPARE PARTS

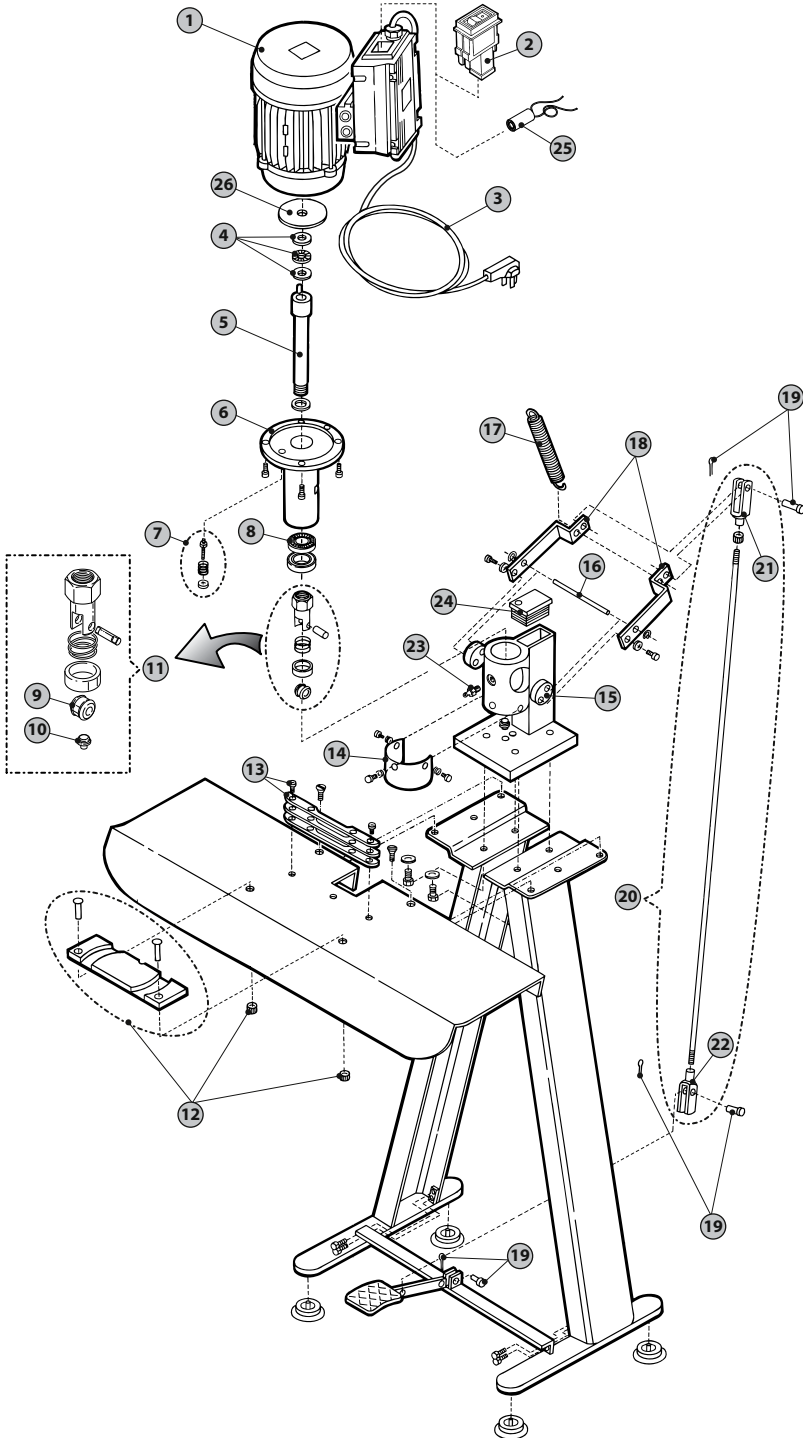

P/N	DESCRIPTION	ORDER MULTIPLES OF:
1 1131004	E-motor 120V~	1 pc
1131003	E-motor 230V~	1 pc
2 1131143	Switch schurter 120V~	1 pc
1150185	Switch eichcoff 230V~	1 pc
3 K00500043	Electric cable 120V~	1 pc
K00500042	Electric cable 230V~	1 pc
4 1131059	Needle bearing	1 pc
5 1131057	Spin shaft	1 pc
6 1131012	E-motor holding flange	1 pc
7 1131056	Clearance adj. Screw kit	1 pc
8 7160003	Bearing 16002-Z	1 pc
9 1131124	Spin roll 3/8"-.404 (A)	1 pc
1131125	Spin roll 90SG-91-1/4"-.325"	1 pc
10 1131126	Thrust anvil (A)	1 pc
1131127	Thrust anvil (B)	1 pc
11 1131130	Kit spinroll-anvil (A) 3/8"-.404	1 pc
1131131	Kit spinroll-anvil (B) 90SG-91-1/4"-.325"	1 pc
12 1131132	Chain guide kit	1 pc
13 1131060	Jaws kit	1 pc
14 1131091	Face shield	1 pc
15 1131011	Cam shaft	2 pcs
16 1131024	Cam pin	1 pc
17 1131027	Lever spring	1 pc
18 1131016	E-motor shifting lever	2 pcs
19 1131055	Kit split pin and pin	1 pc
20 1131109	Bar and yoke kit	1 pc
21 1131036	Zinc yoke	1 pc
22 1131066	Zinc yoke	1 pc
23 1131049	Zerk fitting	2 pcs
24 1131035	Barrel plug	1 pc
25 1131005	Capacitor 120V~ 25mF	1 pc
1131063	Capacitor 230V~ 15mF	1 pc
26 1131013	Shim washer	1 pc

PACKAGING:
Nylon Bag



brushcutter accessories

Forestry and gardening accessories



brushcutter accessories

tick marks legend



Universal mounting without adaptor



Displacement of the brushcutter on which the application is used



Traditional outdoor gardening. Ideal for: grass and small weeds

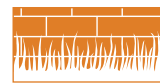

Heavy duty outdoor gardening. Ideal for: grass and large weeds, also around obstacles



Heavy duty outdoor gardening. Ideal for: grass, weeds, reeds, light brush and shrubs



Heavy duty outdoor gardening and forestry. Ideal for: bushes, dense weeds and undergrowth



Forestry. Ideal for: undergrowth with thinning saplings



Packaging:
NYLON BAG
containing bulk items



Packaging:
CLAMSHELL
containing bulk items



Packaging:
CARTON BOX
containing bulk items

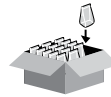

Master pack:
CARTON BOX
containing single nylon bags



Master pack:
CARTON BOX containing
single clamshells

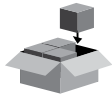

Master pack:
CARTON BOX containing
single boxes



Master pack:
CARTON PALLET containing
bulk items



Max quantity
per PALLET



EASYWork

tap-n-go trimmer head Ø 109 - Ø130



BEST CUT AND PERFORMANCES ENSURED

Mounting in 10'' Refilling in 30''

without disassembling any part
of the trimmer head

PATENT
PENDING

Ø 109 mm
Ø 130 mm

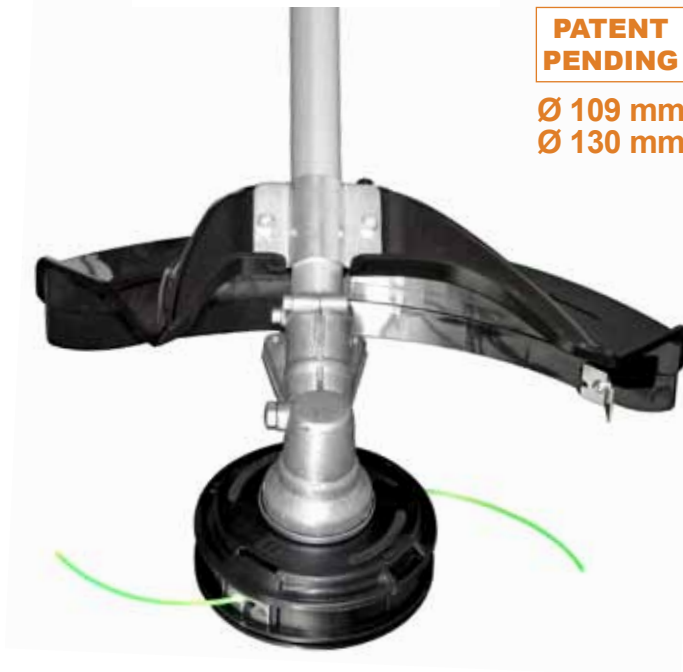

► highlights



Shaped aluminium retainers, to avoid breakage of the line during the work.



Locking hooks head outside the working area of the line.



Easy opening of the head for maintenance and cleaning.



Reinforced knob and easy to handle.
High capacity of line.

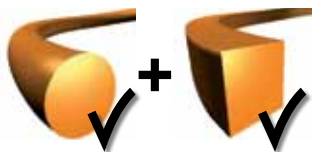

Can be charged with round and square line.



Display packaging (20 pcs x master pack).



Easy and fast mounting on every type of brushcutter.



Refilling without disassembling any part of the trimmer head.



Line loading in 30''.

Adaptors Box



A complete range of adaptors allow to fit every type of brushcutter

P/N	DESCRIPTION	EAN13 CODE
K00401044	Adaptors Box	8032706105828

PACKAGING: Plastic Box
 Q.TY x MASTER PACK: 1 pc
 TOTAL WEIGHT: 2 kg



ORDER MULTIPLES OF: 1 pcs

► highlights









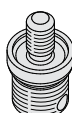
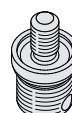
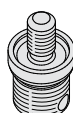
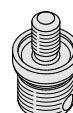

12 different type of adaptors
 120 pcs in total.



A complete range of adaptors, easy to fit
 on the head.

- M 7x1 LH M (10 PCS)
- M 8x1,25 LH M (10 PCS)
- M 10x1,25 LH M (10 PCS)
- M 10x1,5 LH M (10 PCS)
- M 8x1,25 LH F (10 PCS)
- M 10x1 LH F (10 PCS)
- M 10x1,25 LH F (10 PCS)
- M 10x1,5 LH F (10 PCS)
- M 12x1,5 LH F (10 PCS)
- M 12x1,75 LH F (10 PCS)
- 3/8 - 24F LH F (10 PCS)
- M 14x1,5 LH F (10 PCS)

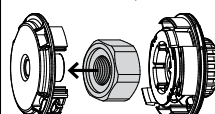
M 7x1 M  LH	M 8x1,25 M  LH	M 10x1,25 M  LH	M 10x1,5 M  LH
M 8x1,25 F  LH	M 10x1 F  LH	M 10x1,25 F  LH	M 10x1,5 F  LH
M 12x1,5 F  LH	M 12x1,75 F  LH	3/8 - 24F F  LH	M 14x1,5 F  LH

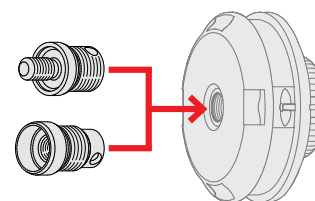

EASYWork

tap-n-go trimmer head Ø109

Easy and reliable.

Tap-N-Go double line head Ø109 mm.

Combines the Tecomec traditional operation reliability with an outstanding and innovative line loading system.

Sturdy construction confirmed by the heaviest internal and severe OEM's field tests.

Fit the most brushcutters on the market.



PATENT PENDING

Ø 109 mm



packaging



Single Pack (1 PC)

- TOP
- Type of adaptor
 - EAN code
 - Part No.

- BACK
- Mounting instructions
 - Loading instructions
 - Technical data



Master Pack (20 PCS)

- FRONT
- Part No.
 - Brushcutter mark and model list

- LEFT/RIGHT SIDE
- Mounting instructions
 - Filling & Loading instructions
 - Technical data

P/N	HEAD TYPE	ADAPTOR TYPE	EAN13 CODE
50729004	Tap-N-Go "MD EW" head	M 10x1,25 LH.F. M 8x1,25 LH.M.	8032706105859
50729005	Tap-N-Go "MD EW" head	M 10x1 LH.F. M 12x1,5 LH.F.	8032706105866
50729003	Tap-N-Go "MD EW" head	NEUTRAL delivered without adaptor (to be ordered separately)	8032706105842

PACKAGING: 1 pc x Carton Box

11,5x7,3x11,5 cm

0,4 kg



Q.TY x MASTER PACK: 20 pcs

MASTER CARTON: 24X37X24 cm

TOTAL WEIGHT: 8,5 kg

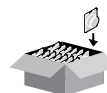

ORDER MULTIPLES OF: 20 pcs

highlights

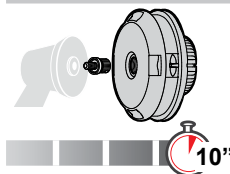

Mounting in 10"

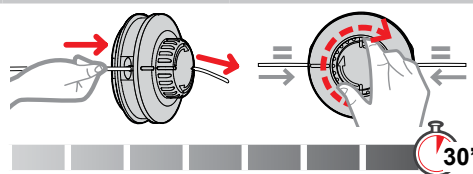

Refilling in 30"

SPARE PARTS

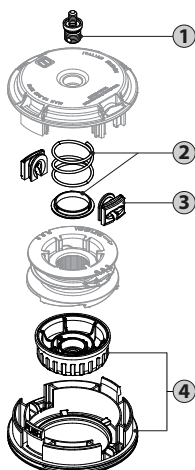

P/N	DESCRIPTION	ORDER MULTIPLES OF:
1 K00401045	Adaptor M 7x1 LH M	10 PCS
K00401061	Adaptor M 8x1,25 LH M	10 PCS
K00401046	Adaptor M 8x1,25 LH F	10 PCS
K00401114	Adaptor M 8x1,25 RH F	10 PCS
K00401047	Adaptor M 10x1 LH F	10 PCS
K00401048	Adaptor M 10x1,25 LH M	10 PCS
K00401062	Adaptor M 10x1,25 LH F	10 PCS
K00401049	Adaptor M 10x1,5 LH M	10 PCS
K00401050	Adaptor M 10x1,5 LH F	10 PCS
K00401051	Adaptor M 12x1,25 LH F	10 PCS
K00401052	Adaptor M 12x1,5 LH F	10 PCS
K00401053	Adaptor M 12x1,75 LH F	10 PCS
K00401054	Adaptor 3/8 - 24F LH F	10 PCS
2 K00401081	Spring kit	10 PCS
3 K00401055	Line retainer	10 PCS
4 K00401082	Cover + knob	10 PCS

PACKAGING:
Nylon Bag



EASYWork

tap-n-go trimmer head Ø130

Easy and reliable.

Tap-N-Go double line head Ø130 mm.

Combines the Tecomec traditional operation reliability with an outstanding and innovative line loading system.

Sturdy construction confirmed by the heaviest internal and severe OEM's field tests.

Fit the most brushcutters on the market.



PATENT PENDING

Ø 130 mm



packaging



Single Pack (1 PC)

TOP
- Type of adaptor
- EAN code
- Part No.

BACK
- Mounting instructions
- Loading instructions
- Technical data



Master Pack (20 PCS)

FRONT
- Part No.
- Brushcutter mark and model list

LEFT/RIGHT SIDE
- Mounting instructions
- Filling & Loading instructions
- Technical data

P/N	HEAD TYPE	ADAPTOR TYPE	EAN13 CODE
50739003	Tap-N-Go "HD EW" head	M 10x1,25 LH.F. M 8x1,25 LH.M.	8032706105644
50739004	Tap-N-Go "HD EW" head	M 10x1 LH.F. M 12x1,5 LH.F.	8032706105651
50739000	Tap-N-Go "HD EW" head NEUTRAL delivered without adaptor (to be ordered separately)		8032706105637

PACKAGING: 1 pc x Carton Box
13,5x7,5x13,5 cm
0,6 kg



Q.TY x MASTER PACK: 20 pcs

MASTER CARTON: 28X38X28 cm

TOTAL WEIGHT: 12,5 kg

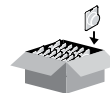

ORDER MULTIPLES OF: 20 pcs

highlights

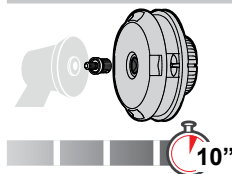

Mounting in 10"

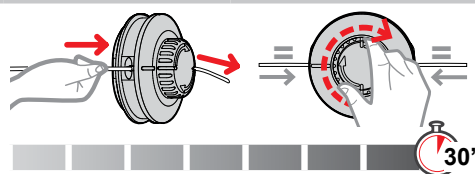

Refilling in 30"

SPARE PARTS

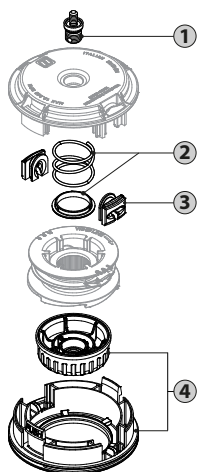

P/N	DESCRIPTION	ORDER MULTIPLES OF:
1 K00401045	Adaptor M 7x1 LH M	10 PCS
K00401061	Adaptor M 8x1,25 LH M	10 PCS
K00401046	Adaptor M 8x1,25 LH F	10 PCS
K00401047	Adaptor M 10x1 LH F	10 PCS
K00401048	Adaptor M 10x1,25 LH M	10 PCS
K00401049	Adaptor M 10x1,5 LH M	10 PCS
K00401062	Adaptor M 10x1,25 LH F	10 PCS
K00401050	Adaptor M 10x1,5 LH F	10 PCS
K00401051	Adaptor M 12x1,25 LH F	10 PCS
K00401052	Adaptor M 12x1,5 LH F	10 PCS
K00401053	Adaptor M 12x1,75 LH F	10 PCS
K00401057	Adaptor M 14x1,5 LH F	10 PCS
K00401054	Adaptor 3/8 - 24F LH F	10 PCS
2 K00401043	Spring kit	10 PCS
3 K00401055	Line retainer	10 PCS
4 K00401042	Cover + knob	10 PCS

PACKAGING:
Nylon Bag



EASYLoad

tap-n-go trimmer head Ø109

Tap-N-Go double line head Ø109 mm, complete with adaptor bolt. Combines the Tecomec traditional operation reliability with an outstanding and innovative line loading system. Sturdy construction confirmed by the heaviest internal and severe OEM's field tests.



PATENT PENDING

Ø 109 mm



► highlights

Easy line refilling without disassembling any part of the trimmer head.

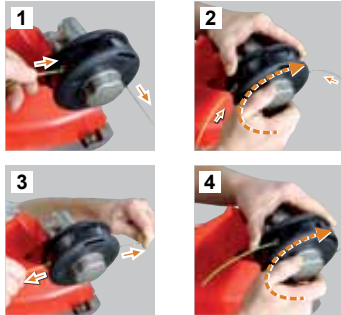

► packaging



FRONT
 - Type of adaptor
 - EAN code
 - Part No.
 - Buschcutter models

BACK
 - Mounting instructions
 - Loading instructions
 - Technical data

P/N	HEAD TYPE	ADAPTOR TYPE		EAN13 CODE
50719026	Tap-N-Go "MD EL" head	M8x1,25	LH.M. (fits EMAK only)	8032706102698
50719027	Tap-N-Go "MD EL" head	M8x1,25	LH.F.	8032706102704
50719014	Tap-N-Go "MD EL" head	M 8x1,25	LH.M.	8032706102896
50719028	Tap-N-Go "MD EL" head	M10x1	LH.F. (fits STHIL only)	8032706102711
50719029	Tap-N-Go "MD EL" head	M10x1,25	LH.F.	8032706102728
50719030	Tap-N-Go "MD EL" head	M10x1,25	LH.F. (fits HU only)	8032706102735
50719038	Tap-N-Go "MD EL" head	NEUTRAL - delivered without adaptor		8032706103091

PACKAGING:

1 pc x
Clamshell



Q.TY x MASTER PACK: 12 pcs

MASTER CARTON: 55x31,5x17 cm
TOTAL WEIGHT: 5,0 kg



ORDER MULTIPLES OF: 12 pcs

► SPARE PARTS

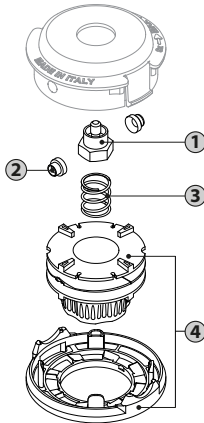

P/N	DESCRIPTION	ORDER MULTIPLES OF:
1 5070021	Adaptor M 7 x 1 LH.F.	10 PCS
100003002	Adaptor M 8 x 1.25 LH.M. (fits EMAK only)	10 PCS
5070011	Adaptor M 8 x 1.25 LH.F.	10 PCS
5070020	Adaptor M 8 x 1.25 LH.M.	10 PCS
5070026	Adaptor M 10 x 1.00 LH.F. (fits ST only)	10 PCS
5070008	Adaptor M 10 x 1.25 LH.F.	10 PCS
5070024	Adaptor M 10 x 1.25 LH.F. (fits HU only)	10 PCS
5070032	Adaptor M 10 x 1.50 LH.F. (fits HU only)	10 PCS
100003000	Adaptor 3/8"-24 LH.F.	10 PCS
2 K00401009	Line retainer	10 PCS
3 K00401035	Spring	10 PCS
4 K00401033	Cover + spool kit	10 PCS

PACKAGING:

Nylon Bag



EASYLoad

tap-n-go trimmer head Ø130

Tap-N-Go double line head Ø130 mm complete with adaptor bolt. Combines the Tecomec traditional operation reliability with an outstanding and innovative line loading system. Sturdy construction confirmed by the heaviest internal and severe OEM's field tests.



PATENT PENDING

Ø 130 mm



► highlights

Easy line refilling without disassembling any part of the trimmer head.

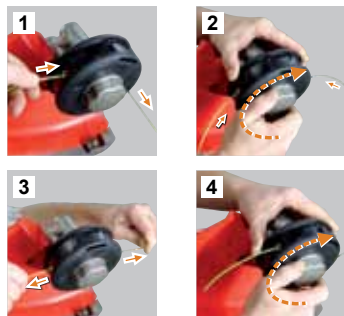

► packaging



FRONT
 - Type of adaptor
 - EAN code
 - Part No.
 - Buscutter models

BACK
 - Mounting instructions
 - Loading instructions
 - Technical data

P/N	HEAD TYPE	ADAPTOR TYPE	EAN13 CODE
50709006	Tap-N-Go "HD EL" head	M12x1,25 LH.F. (fits XEN only)	8032706102773
50709007	Tap-N-Go "HD EL" head	M8x1,25 LH.M. (fits EMAK only)	8032706102780
50709008	Tap-N-Go "HD EL" head	M 8x1,25 LH.F.	8032706102797
50709015	Tap-N-Go "HD EL" head	M10x1,25 LH.F.	8032706102803
50709033	Tap-N-Go "HD EL" head	M10x1,25 LH.M.	8032706102629
50709034	Tap-N-Go "HD EL" head	M12x1,50 LH.F. M14x1,5 LH.F.	8032706102636
50709005	Tap-N-Go "HD EL" head	M 8x1,25 LH.M.	8032706102766
50709035	Tap-N-Go "HD EL" head	M10x1 LH.F. (fits STHIL only)	8032706102643
50709036	Tap-N-Go "HD EL" head	M10x1,50 LH.M. (fits MC only)	8032706102650
50709038	Tap-N-Go "HD EL" head	M12x1,75 LH F (fits HU only)	8032706102674
50709039	Tap-N-Go "HD EL" head	M10x1,25 LH F (fits HU only)	8032706102681
50709045	Tap-N-Go "HD EL" head	M12X1.5 LH F (fits STHIL only)	8032706102919
50709048	Tap-N-Go "HD EL" head	M10x1,50 LH F (fits HU only)	8032706103060
50709037	Tap-N-Go "HD EL" head	NEUTRAL - delivered without adaptor	8032706102667

PACKAGING:
 1 pc x
 Clamshell



Q.TY x MASTER PACK: 12 pcs
MASTER CARTON: 55x31,5x17 cm
TOTAL WEIGHT: 7,5 kg

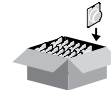

ORDER MULTIPLES OF: 12 pcs

► SPARE PARTS

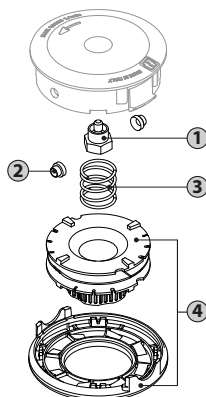

P/N	DESCRIPTION	ORDER MULTIPLES OF:
1 I00003002	Adaptor M8x1,25 LH.M.(fits EMAK only)	10 PCS
5070020	Adaptor M8x1,25 LH.M.	10 PCS
5070011	Adaptor M8x1,25 LH.F.	10 PCS
5070027	Adaptor M10x1,5 LH.M.(fits MC only)	10 PCS
5070026	Adaptor M10x1 LH.F. (fits ST only)	10 PCS
5070008	Adaptor M10x1,25 LH.F.	10 PCS
5070024	Adaptor M10x1,25 LH. F. (fits HU only)	10 PCS
5070009	Adaptor M10x1,25 LH.M.	10 PCS
I00003001	Adaptor M12x1,25 LH.F. (fits XEN only)	10 PCS
5070032	Adaptor M10x1,5 LH. F. (fits HU only)	10 PCS
5070010	Adaptor M12x1,5 LH.F. (fits STL only)	10 PCS
5070028	Adaptor M12x1,75 LH. F. (fits HU only)	10 PCS
5070039	Adaptor M14x1,5 LH.F. (fits ST only)	10 PCS
2 K00401009	Line retainer	10 PCS
3 K00401036	Spring kit	10 PCS
4 K00401034	Cover + spool kit	10 PCS

PACKAGING:
 Nylon Bag



EASYLoad

tap-n-go trimmer head Ø109

Universal Mounting



Tap-N-Go double line head Ø109 mm, universal mounting without adaptor, centering bore for both 20÷25.4 mm.

Delivered complete with kit of adaptor washers. Combines the Tecomec traditional operation reliability with an outstanding and innovative line loading system.

Sturdy construction confirmed by the heaviest internal and severe OEM's field tests.



PATENT PENDING

NO BOLT SHAFT
UNIVERSAL MOUNTING



Ø 109 mm

packaging



FRONT

- Type of adaptor
- EAN code
- Part No.
- Buschcutter models

BACK

- Mounting instructions
- Loading instructions
- Technical data

P/N	DESCRIPTION	EAN13 CODE
50719039	Tap-N-Go "MD EL" universal head Ø109	8032706103657

PACKAGING:

1 pc x
Clamshell



Q.TY x MASTER PACK:

12 pcs

MASTER CARTON:

55x31,5x17 cm

TOTAL WEIGHT:

5,0 kg



ORDER MULTIPLES OF: 12 pcs

highlights

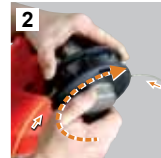

Easy line refilling without disassembling any part of the trimmer head.

SPARE PARTS

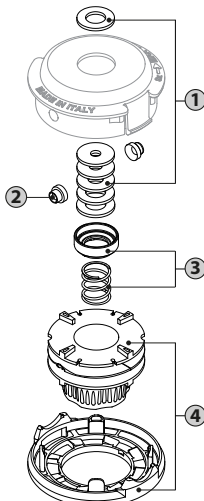

P/N	DESCRIPTION	ORDER MULTIPLES OF:
1 K00401008	Kit of adaptor washers and reduction rings	10 kits
2 K00401009	Line retainer	10 PCS
3 K00401035	Spring kit	10 PCS
4 K00401033	Cover + spool kit	10 PCS

PACKAGING:
Nylon Bag



EASYLoad

tap-n-go trimmer head Ø130

Universal Mounting



Tap-N-Go double line head Ø130 mm, universal mounting without adaptor, centering bore for both 20÷25.4 mm.

Delivered complete with kit of adaptor washers. Combines the Tecomec traditional operation reliability with an outstanding and innovative line loading system.

Sturdy construction confirmed by the heaviest internal and severe OEM's field tests.



PATENT PENDING

NO BOLT SHAFT

UNIVERSAL MOUNTING



Ø 130 mm

packaging



FRONT

- Type of adaptor
- EAN code
- Part No.
- Buschcutter models

BACK

- Mounting instructions
- Loading instructions
- Technical data

P/N	DESCRIPTION	EAN13 CODE
50709056	Tap-N-Go "HD EL" universal head Ø130	8032706103572

PACKAGING:

1 pc x
Clamshell



Q.TY x MASTER PACK:

12 pcs

MASTER CARTON:

55x31,5x17 cm

TOTAL WEIGHT:

5,0 kg

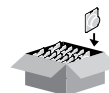

ORDER MULTIPLES OF: 12 pcs

highlights

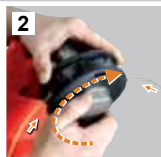

Easy line refilling without disassembling any part of the trimmer head.

SPARE PARTS

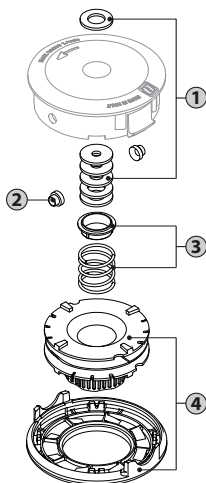

P/N	DESCRIPTION	ORDER MULTIPLES OF:
1 K00401008	Kit of adaptor washers and reduction rings	10 kits
2 K00401009	Line retainer	10 PCS
3 K00401036	Spring kit	10 PCS
4 K00401034	Cover + spool kit	10 PCS

PACKAGING:
Nylon Bag



MINI EasyLoad

tap-n-go trimmer head Ø109



Any Trimmer Head is supplied single packed in a nice clamshell for Wall Display Package.



PATENT PENDING



Ø 109 mm



packaging



FRONT

- EAN code
- Part No.
- Buscutter models

BACK

- Mounting instructions
- Loading instructions
- Technical data

P/N	DESCRIPTION		EAN13 CODE
50719040	Suitable to: Homelite DA03001 / Da03001 A Dual line head with 5/16" Bump knob Fits: ST155, ST165, ST285 and more. Also Black & Dekker		8032706103824
50719042	Suitable to: RYOBI 153577 Dual line head with 5/16" Bump knob. Fits: 700R, 710R, 720R, 740R, 75R, 760R, 765R, 766R, 770R, 920R, 970R, CS720R, SS720R and more.		8032706103848
50719041	Suitable to: McCulloch / Alko / MTD two line bump feed with 1/4" Bump knob. Fits: Promac, MK1, MK2 & MK3.		8032706103831

PACKAGING:

1 pc x
Clamshell



Q.TY x MASTER PACK: **12 pcs**

MASTER CARTON: 55x31,5x17 cm

TOTAL WEIGHT: 5,0 kg

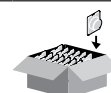

ORDER MULTIPLES OF: 12 pcs

SPARE PARTS

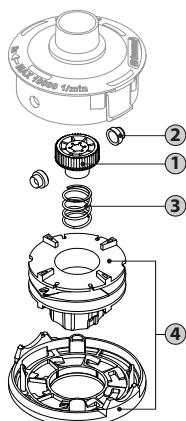

P/N	DESCRIPTION	ORDER MULTIPLES OF:
1	K00401014 5/16" 18 RFH knob kit	10 PCS
	K00401015 1/4" 18 RFH knob kit	10 PCS
2	K00401009 Line retainer	5 PCS
3	M00200012 Spring	10 PCS
4	K00401037 Cover + spool kit	10 PCS

PACKAGING:

Nylon Bag



Tap-N-Go

trimmer head Ø109

Double line nylon head Ø 109 mm complete with adaptor bolt - Ø 2 mm nylon line.



Ø 109 mm



P/N	HEAD TYPE	ADAPTOR TYPE	EAN13 CODE
50719025	Tap-N-Go head	M7x1 LH.M	8032706104159
50719015	Tap-N-Go head	M8x1.25 LH.M. (fits EMAK only)	8032706104166
50719016	Tap-N-Go head	M8x1.25 LH.F.	8032706104173
50719017	Tap-N-Go head	M8x1.25 LH.M.	8032706104180
50719018	Tap-N-Go head	M10x1 LH.F. (fits STIHL only)	8032706104197
50719019	Tap-N-Go head	M10x1.25 LH.F.	8032706104203
50719020	Tap-N-Go head	M10x1.25 LH.F. (fits HU only)	8032706104210
50719021	Tap-N-Go head	M10x1.25 LH.M.	8032706104227
50719022	Tap-N-Go head	M10x1.5 LH.F. (fits HU only)	8032706104234
50719035	Tap-N-Go head	M10x1,5 LH.M. (fits MC only)	8032706104265
50719023	Tap-N-Go head	3/8" - 24 LH.F.	8032706104241
50719024	Tap-N-Go head NEUTRAL - delivered without adaptor		8032706105033

PACKAGING:
1 pc x
Nylon Bag



Q.TY x MASTER PACK: **40 pcs**
MASTER CARTON: 42x37x29 cm
TOTAL WEIGHT: 14 kg



ORDER MULTIPLES OF: **40 pcs**

SPARE PARTS

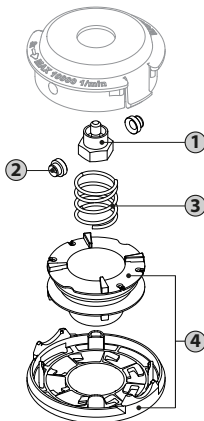

P/N	DESCRIPTION	ORDER MULTIPLES OF:
1 5070021	Adaptor M 7 x 1 LH.F.	10 PCS
100003002	Adaptor M 8 x 1.25 LH.M. (fits EMAK only)	10 PCS
5070011	Adaptor M 8 x 1.25 LH.F.	10 PCS
5070031	Adaptor M 8 x 1.25 RH.F.	10 PCS
5070020	Adaptor M 8 x 1.25 LH.M.	10 PCS
5070026	Adaptor M 10 x 1.00 LH.F. (fits ST only)	10 PCS
5070023	Adaptor M 10 x 1.00 LH.F.	10 PCS
5070008	Adaptor M 10 x 1.25 LH.F.	10 PCS
5070024	Adaptor M 10 x 1.25 LH.F. (fits HU only)	10 PCS
5070009	Adaptor M 10 x 1.25 LH.M.	10 PCS
5070032	Adaptor M 10 x 1.50 LH.F. (fits HU only)	10 PCS
5070027	Adaptor M 10 x 1.50 LH.F. (fits MC only)	10 PCS
100003000	Adaptor 3/8"-24 LH.F.	10 PCS
2 5070005	Line retainer	10 PCS
3 K00401036	Spring	10 PCS
4 K00401038	Cover + spool kit	10 PCS

PACKAGING:
Nylon Bag



Tap-N-Work

trimmer head Ø130



Ø 130 mm



Double line nylon head Ø 130 mm complete with adaptor bolt. - High capacity spool: 10 m of Ø2,4 mm line / 8 m of Ø2,7 mm line.

- New design, handy and sturdy.
- Higher flexibility spring for better line consumption control.
- Extremely balanced at any rpm range.
- Anti line-entangling design.
- And always the traditional Tecomec consistent standard of high quality products and reliable service.
- Standard type for adaptor insertion .

packaging



FRONT

- Type of adaptor
- EAN code
- Part No.
- Buscutter models

BACK

- Mounting instructions
- Loading instructions
- Technical data

P/N	HEAD TYPE	ADAPTOR TYPE	EAN13 CODE
50709010	Tap-N-Go head	M8x1.25 LH.M. (fits EMAK only)	8032706103879
50709011	Tap-N-Go head	M8x1.25 LH.F.	8032706103909
50709016	Tap-N-Go head	M8x1.25 LH.M.	8032706103947
50709017	Tap-N-Go head	M10x1.00 LH.F. (fits STIHL only)	8032706103954
50709012	Tap-N-Go head	M10x1.25 LH.F.	8032706103916
50709022	Tap-N-Go head	M10x1.25 LH.F. (fits HU only)	8032706104005
50709013	Tap-N-Go head	M10x1.25 LH.M.	8032706103923
50709018	Tap-N-Go head	M10x1.50 LH.M. (fits MC only)	8032706103961
50709009	Tap-N-Go head	M12x1.25 LH.F. (fits XEN only)	8032706103992
50709014	Tap-N-Go head	M12x1.50 LH.F. M14x1.50 LH.F.	8032706103930
50709021	Tap-N-Go head	M12x1.75 LH.F. (fits HU only)	8032706103985
50709019	Tap-N-Go head	NEUTRAL - delivered without adaptor	8032706103978

PACKAGING:

1 pc x
Carton Hanger



Q.TY x MASTER PACK: 30 pcs

MASTER CARTON: 53x37x29 cm

TOTAL WEIGHT: 20 kg

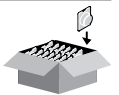

ORDER MULTIPLES OF: 30 pcs

SPARE PARTS

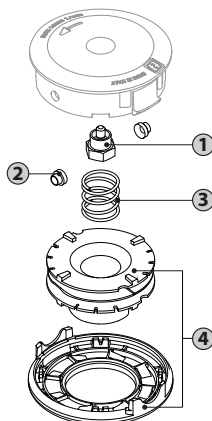

P/N	DESCRIPTION	ORDER MULTIPLES OF:
1 I00003002	Adaptor M8x1,25 LH.M.(fits EMAK only)	10 PCS
5070020	Adaptor M8x1,25 LH.M.	10 PCS
5070011	Adaptor M8x1,25 LH.F.	10 PCS
5070027	Adaptor M10x1,5 LH.M.(fits MC only)	10 PCS
5070031	Adaptor M 8 x 1.25 RH.F.	10 PCS
5070026	Adaptor M10x1 LH.F. (fits ST only)	10 PCS
5070008	Adaptor M10x1,25 LH.F.	10 PCS
5070024	Adaptor M10x1,25 LH. F. (fits HU only)	10 PCS
5070009	Adaptor M10x1,25 LH.M.	10 PCS
I00003001	Adaptor M12x1,25 LH.F. (fits XEN only)	10 PCS
5070032	Adaptor M10x1,5 LH. F. (fits HU only)	10 PCS
5070010	Adaptor M12x1,5 LH.F. (fits STL only)	10 PCS
5070028	Adaptor M12x1,75 LH. F. (fits HU only)	10 PCS
5070039	Adaptor M14x1,5 LH.F. (fits ST only)	10 PCS
2 K00401009	Line retainer	10 PCS
3 K00401036	Spring kit	10 PCS
4 K00401039	Cover + spool kit	10 PCS

PACKAGING:
Nylon Bag



SUPERPro

trimmer head Ø130



Ø 130 mm

Evolution of traditionally top performing Tecomec Tap-N-Go head. Reinforced nylon spool makes this sturdy head most suitable for professional service contractors and landscaping all-day-duty operations.

- Line spool with zinc plated steel insert. Extreme wear resistance.
- 30% higher wrapping capacity than traditional Tecomec Tap-N-Go heads.



► highlights



- Line spool interchangeable with spool p/n 5070003 of traditional tecomec tap-n-go heads and also available separately.
- Wrapping capacity increased +30% !



- Reinforced steel plate.
- Low vibrations.

P/N	HEAD TYPE	ADAPTOR TYPE	EAN13 CODE
50769008	Tap-N-Go "HD SP" head	M12x1.25 LH.F. (fits ZE only)	8032706103008
50769000	Tap-N-Go "HD SP" head	M8x1.25 LH.M. (fits EMAK only)	8032706102926
50769004	Tap-N-Go "HD SP" head	M10x1.25 LH.F.	8032706102964
50769009	Tap-N-Go "HD SP" head	M12x1.50 M14x1.50	8032706103015
50769002	Tap-N-Go "HD SP" head	M8x1.25 LH.M.	8032706102940
50769003	Tap-N-Go "HD SP" head	M10x1,00 LH.F. (fits ST only)	8032706102957
50769007	Tap-N-Go "HD SP" head	M10x1,50 LH.M. (fits MC only)	8032706102995
50769010	Tap-N-Go "HD SP" head	M12x1,75 LH.F. (fits HU only)	8032706103022
50769005	Tap-N-Go "HD SP" head	M10x1,25 LH.F. (fits HU only)	8032706102971
50769011	Tap-N-Go "HD SP" head	NEUTRAL - delivered without adaptor	8032706103039

PACKAGING:
1 pc x
Nylon Bag



Q.TY x MASTER PACK: 50 pcs
MASTER CARTON: 39,5x39,5x40,5 cm
TOTAL WEIGHT: 26,5 kg



ORDER MULTIPLES OF: 50 pcs

► SPARE PARTS

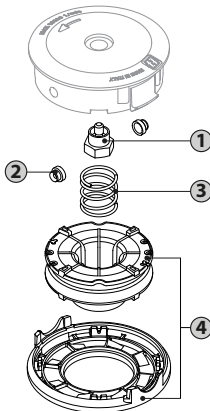

P/N	DESCRIPTION	ORDER MULTIPLES OF:
1 I00003002	Adaptor M8x1,25 LH.M.(fits EMAK only)	10 PCS
5070020	Adaptor M8x1,25 LH.M.	10 PCS
5070011	Adaptor M8x1,25 LH.F.	10 PCS
5070031	Adaptor M 8 x 1.25 RH.F.	10 PCS
5070027	Adaptor M10x1,5 LH.M.(fits MC only)	10 PCS
5070026	Adaptor M10x1 LH.F. (fits ST only)	10 PCS
5070008	Adaptor M10x1,25 LH.F.	10 PCS
5070024	Adaptor M10x1,25 LH. F. (fits HU only)	10 PCS
5070009	Adaptor M10x1,25 LH.M.	10 PCS
I00003001	Adaptor M12x1,25 LH.F. (fits XEN only)	10 PCS
5070032	Adaptor M10x1,5 LH. F. (fits HU only)	10 PCS
5070010	Adaptor M12x1,5 LH.F. (fits STL only)	10 PCS
5070028	Adaptor M12x1,75 LH. F. (fits HU only)	10 PCS
5070039	Adaptor M14x1,5 LH.F. (fits ST only)	10 PCS
2 K00401009	Line retainer	10 PCS
3 K00401036	Spring kit	10 PCS
4 K00401040	Cover + spool kit	10 PCS

PACKAGING:
Nylon Bag



Tap-N-Go

trimmer head Ø160

Double line nylon head Ø160 mm - Ø3 mm nylon line.



Ø 160 mm

NEUTRAL

Trimmer head delivered without adaptor, please order the adaptor separately

P/N	DESCRIPTION	EAN13 CODE
5075901	Tap-N-Go head NEUTRAL - delivered without adaptor adaptor	8032706104272

PACKAGING:
1 pc x
Nylon Bag



Q.TY x MASTER PACK: **35 pcs**
MASTER CARTON: 39,5x39,5x40,5 cm
TOTAL WEIGHT: 24 kg

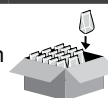

ORDER MULTIPLES OF: 35 pcs

P/N	HEAD TYPE	ADAPTOR TYPE	EAN13 CODE
5075902	Tap-N-Go head	M8x1.25 LH.M (fits EMAK only)	8032706104296
50759000	Tap-N-Go head	M12x1.75 LH.F. (fits HU only)	8032706104289

PACKAGING:
1 pc x
Nylon Bag



Q.TY x MASTER PACK: **35 pcs**
MASTER CARTON: 39,5x39,5x40,5 cm
TOTAL WEIGHT: 24 kg

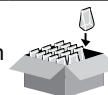

ORDER MULTIPLES OF: 35 pcs

SPARE PARTS

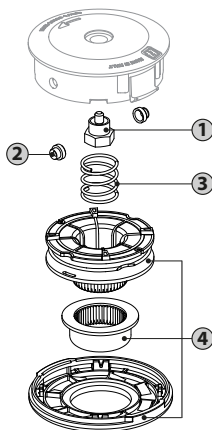

P/N	DESCRIPTION	ORDER MULTIPLES OF:
1 I0003002	Adaptor M8x1,25 LH.M.(fits EMAK only)	10 PCS
5070020	Adaptor M8x1,25 LH.M.	10 PCS
5070011	Adaptor M8x1,25 LH.F.	10 PCS
5070027	Adaptor M10x1,5 LH.M.(fits MC only)	10 PCS
5070026	Adaptor M10x1 LH.F. (fits ST only)	10 PCS
5070008	Adaptor M10x1,25 LH.F.	10 PCS
5070024	Adaptor M10x1,25 LH. F. (fits HU only)	10 PCS
5070009	Adaptor M10x1,25 LH.M.	10 PCS
I0003001	Adaptor M12x1,25 LH.F. (fits XEN only)	10 PCS
5070032	Adaptor M10x1,5 LH. F. (fits HU only)	10 PCS
5070010	Adaptor M12x1,5 LH.F. (fits STL only)	10 PCS
5070028	Adaptor M12x1,75 LH. F. (fits HU only)	10 PCS
5070039	Adaptor M14x1,5 LH.F. (fits ST only)	10 PCS
2 K00401009	Line retainer	10 PCS
3 5075006	Spring	10 PCS
4 K00401041	Cover + spool kit	10 PCS

PACKAGING:
Nylon Bag



Tap-N-Work

trimmer head Ø109

Universal Mounting





Semi-automatic head "pro universal". Tap-N-go double line head, universal mounting without adaptor, centering bore for both 20÷25.4 mm - Ø 2,4 mm nylon line.

Delivered complete with kit of adaptor washers.



Ø 109 mm

P/N	DESCRIPTION	EAN13 CODE
50719044	Tap-N-Go universal head Ø109	8032706104302
PACKAGING: 1 pc x Nylon Bag  Q.TY x MASTER PACK: 40 pcs MASTER CARTON: 42x37x29 cm TOTAL WEIGHT: 17 kg 		
ORDER MULTIPLES OF: 40 pcs		

SPARE PARTS

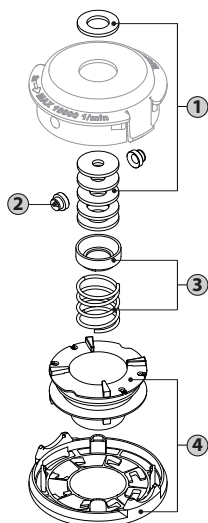

P/N	DESCRIPTION	ORDER MULTIPLES OF:
1 K00401008	Kit of adaptor washers and reduction rings	10 kits
2 5070005	Line retainer	10 PCS
3 K00401036	Spring kit	10 PCS
4 K00401038	Cover + spool kit	10 PCS

PACKAGING:
Nylon Bag



Tap-N-Work

trimmer head Ø130

Universal Mounting



Semi-automatic head "pro universal". Tap-N-Go double line head, universal mounting without adaptor, centering bore for both 20+25.4 mm - Ø 2,4 mm nylon line.

Delivered complete with kit of adaptor washers.



Ø 130 mm

P/N	DESCRIPTION	EAN13 CODE
5070911	Tap-N-Go universal head Ø130	8032706104319

PACKAGING:

1 pc x
Nylon Bag



Q.TY x MASTER PACK: 40 pcs

MASTER CARTON: 58x40x35 cm

TOTAL WEIGHT: 23 kg

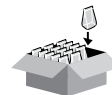

ORDER MULTIPLES OF: 40 pcs

SPARE PARTS

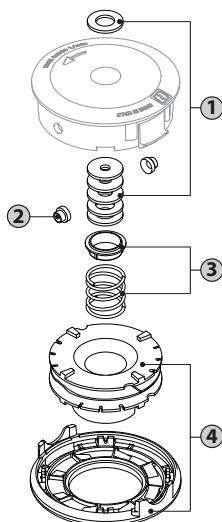

P/N	DESCRIPTION	ORDER MULTIPLES OF:
1 K00401008	Kit of adaptor washers and reduction rings	10 kits
2 K00401009	Line retainer	10 PCS
3 K00401036	Spring + spacer kit	10 PCS
4 K00401039	Cover + spool kit	10 PCS

PACKAGING:

Nylon Bag



SUPERPro

trimmer head Ø130

Universal Mounting



Evolution of traditionally top performing Tecomec Tap-N-Go head. Reinforced nylon spool makes this sturdy head most suitable for professional service contractors and landscaping all-day-duty operations.

- Line spool with zinc plated steel insert. Extreme wear resistance.
- 30% higher wrapping capacity than traditional Tecomec Tap-N-Go heads.



> 33cc

NO BOLT SHAFT

UNIVERSAL MOUNTING

adaptor washers included

Ø 130 mm

► highlights





- Line spool interchangeable with spool p/n 5070003 of traditional tecomec tap-n-go heads and also available separately.
- Wrapping capacity increased +30% !



- Reinforced steel plate.
- Low vibrations.

P/N	DESCRIPTION	EAN13 CODE
50769012	Tap-N-Go "HD SP" universal head	8032706103664

PACKAGING:		Q.TY x MASTER PACK: 50 pcs	
1 pc x Nylon Bag		MASTER CARTON: 39,5x39,5x40,5 cm	
		TOTAL WEIGHT: 22,5 kg	

ORDER MULTIPLES OF: 50 pcs

► SPARE PARTS

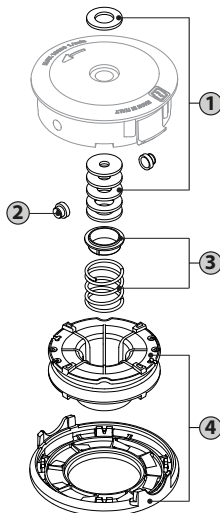

P/N	DESCRIPTION	ORDER MULTIPLES OF:
1 K00401008	Kit of adaptor washers and reduction rings	10 kits
2 K00401009	Line retainer	10 PCS
3 K00401036	Spring kit	10 PCS
4 K00401040	Cover + spool kit	10 PCS

PACKAGING: Nylon Bag 

MINITap-N-Go

trimmer head



Any Trimmer Head is supplied single packed in a nice clamshell for Wall Display Package.





packaging



FRONT
 - Part No.
 - Buschcutter models

BACK
 - Instructions
 - EAN code

P/N	DESCRIPTION	
50909001	suitable to: Homelite DA03001 / Da03001 A Dual line head with 5/16" Bump knob fits ST155, ST165, ST285 and more. Also Black & Dekker	
50909003	suitable to: RYOBI 153577 Dual line head with 5/16" Bump knob. Fits 700R, 710R, 720R, 740R, 75R, 760R, 765R, 766R, 770R, 920R, 970R, CS720R, SS720R and more.	
50909004	suitable to: McCulloch two line bump feed with 1/4" Bump knob. Fits Promac, MK1, MK2 & MK3.	

PACKAGING:
 1 pc x
 Clamshell



Q.TY x MASTER PACK: 40 pcs
MASTER CARTON: 56x38x28 cm
TOTAL WEIGHT: 8 kg

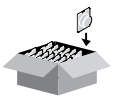

ORDER MULTIPLES OF: 40 pcs

PROType

manual head



Double line nylon head complete with adaptor bolt, aluminium knob - Ø 2,4 mm nylon line.

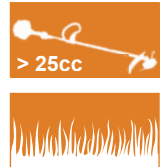

P/N	HEAD TYPE	ADAPTOR TYPE		EAN13 CODE
5030901	Manual head	M7x1.00	LH.M.	8032706104326
5030903	Manual head	M8x1.25	LH.M.	8032706104333
5030904	Manual head	M8x1.25	LH.M. (fits EMAK only)	8032706104340
5030907	Manual head	M8x1.25	LH.F.	8032706104357
5030911	Manual head	M10x1.00	LH.F. (fits HU only)	8032706104371
5030910	Manual head	M10x1.00	LH.F. (fits ST only)	8032706104364
5030913	Manual head	M10x1.25	LH.F.	8032706104388
5030914	Manual head	M10x1.25	LH.M.	8032706104395
5030915	Manual head	M10x1.50	LH.F.	8032706104401
5030917	Manual head	M12x1.50	LH.F. (fits ST only)	8032706104418
5030918	Manual head	M12x1.75	LH.F. (fits HU only)	8032706104425

PACKAGING:
1 pc x
Nylon Bag



Q.TY x MASTER PACK: 50 pcs
MASTER CARTON: 40x39x32 cm
TOTAL WEIGHT: 15 kg



ORDER MULTIPLES OF: 50 pcs

SPARE PARTS

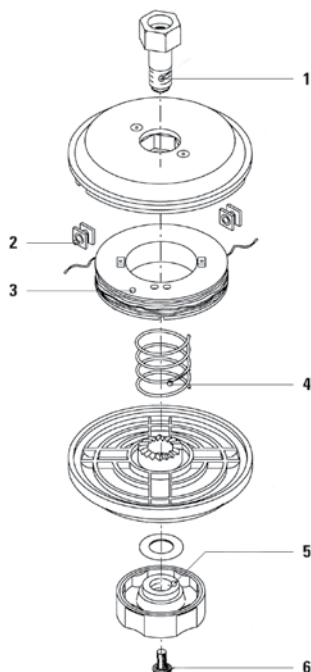

P/N	DESCRIPTION	ORDER MULTIPLES OF:
1 5030015	Adaptor M 7 x 1.00 LH.M.	10 PCS
5030018	Adaptor M 8 x 1.25 LH.M.	10 PCS
5030044	Adaptor M 8 x 1.25 LH.M. (fits EMAK only)	10 PCS
5030021	Adaptor M 8 x 1.25 LH.F.	10 PCS
5030025	Adaptor M 10 x 1.00 LH.F. (fits HU only)	10 PCS
5030024	Adaptor M 10 x 1.00 LH.F. (fits ST only)	10 PCS
5030027	Adaptor M 10 x 1.25 LH.F.	10 PCS
5030028	Adaptor M 10 x 1.25 LH.M.	10 PCS
5030029	Adaptor M 10 x 1.50 LH.F.	10 PCS
5030031	Adaptor M 12 x 1.50 LH.F.	10 PCS
5030032	Adaptor M 12 x 1.75 LH.F.	10 PCS
2 5030011	Line retainer (square)	10 PCS
3 5030014	Spool without line	5 PCS
5030043	Spool with line (6m)	5 PCS
4 5030010	Spool spring	10 PCS
5 5030009	Left knob	10 PCS
5030013	Right knob	10 PCS
6 5030012	Knob screw	10 PCS

PACKAGING:
Nylon Bag



Adaptor Chart



				HEAD MODEL						
ADAPTOR TYPE		ADAPTOR P/N	EASYLoad Ø109	EASYLoad Ø130	Tap-N-Go Ø109	Tap-N-Work Ø130	SUPERPro Ø130	Tap-N-Go Ø160	PROType	PROTrim
										
			Page 72	Page 73	Page 77	Page 78	Page 79	Page 80	Page 85	Page 111
M 7		M 7x1 LH.M.	5070021	✓		✓				
		M 7x1 LH.M.	5030015						✓	
M 8		M 8x1,25 LH.M.	5030018						✓	
		M 8x1,25 LH.M. (EMAK only)	5030044						✓	
		M 8x1,25 LH.M.	5070020	✓	✓	✓	✓	✓	✓	✓
		M 8x1,25 LH.M. (EMAK only)	100003002	✓	✓	✓	✓	✓	✓	✓
		M 8x1,25 LH.F.	5030021						✓	
		M 8x1,25 LH.F.	5070011	✓	✓	✓	✓	✓	✓	✓
M 10		M 10x1 LH.F. (HU only)	5030025						✓	
		M 10x1 LH.F. (ST only)	5030024						✓	
		M 10x1 LH.F.	5070023			✓				
		M 10x1 LH.F. (ST only)	5070026	✓	✓	✓	✓	✓	✓	✓
		M 10x1.25 LH.M.	5030028						✓	



Adaptor Chart



	ADAPTOR TYPE	ADAPTOR P/N	HEAD MODEL							PROType	PROTrim
			EASYLoad Ø109	EASYLoad Ø130	Tap-N-Go Ø109	Tap-N-Work Ø130	SUPERPro Ø130	Tap-N-Go Ø160			
M 10	 M 10x1.25 LH.M.	5070009		✓	✓	✓	✓	✓	✓		✓
	 M 10x1.25 LH.F.	5030027								✓	
	 M 10x1.25 LH.F.	5070008	✓	✓	✓	✓	✓	✓	✓		✓
	 M 10x1,25 LH.F. (HU only)	5070024	✓	✓	✓	✓	✓	✓	✓		✓
	 M 10x1,5 LH.M. (MC only)	5070027		✓	✓	✓	✓	✓	✓		✓
	 M 10x1,5 LH.F.	5030029								✓	
	 M 10x1,5 LH.F. (HU only)	5070032	✓	✓	✓	✓	✓	✓	✓		✓
M 12	 M 12x1.5 LH.F. (ST only)	5070010		✓		✓	✓	✓	✓		✓
	 M 12x1,25 LH.F.	100003001		✓		✓	✓	✓	✓		✓
	 M 12x1,75 LH.F. (HU only)	5030032								✓	
	 M 12x1,75 LH.F. (HU only)	5070028		✓		✓	✓	✓	✓		✓
	 M 14x1.5 LH.F.	5070039		✓		✓	✓	✓	✓		✓
3/8-24	 3/8-24 UNF LH.F.	100003000	✓		✓						

Guide list for nylon head adaptors

BRAND	MODEL	ADAPTOR
ALKO	MS400, 106146	M10x1,25 LH F
	106389, 106144, 106436, 106145	M8x1,25 LH F
	LT250C	M8x1,25 LH M
ALPINA	170, 180, 190, 200	M8x1,25 LH M EFCO
ALPINA / CASTOR	210, 220	M10x1,25 LH F
	VIP21, VIP25, VIP30, VIP34, VIP34D, VIP34F, VIP42, VIP35F, VIP52, VIP52D, VIP52F, VIP42D, VIP42F	M8x1,25 LH F
ARMITSU	ACC15, ACC17, ACD-17, ACD18, ACE30, ACZEK, AM-16D, AM-24, AM-24D, AM-31, AM-31K, AM-31KL, AM40, AM50	M8x1,25 LH M
BLUEBIRD	SBC23E, 27E, NBC31EA, NBC38E, M47, M54	M10x1 LH F ST
DOLMAR	BC337, BC377, NB26, NB03, NB04, NB31, NB40, MS3500, NB40, NB411, NB50, NB351, BD330, C250, LT-250	M10x1 LH F ST
	MS340, BC12, BC210, BC212, MS5250, BC210, BC212, MS30C, MS30U	M10x1,25 LH F
	BC250, LT250, BC330, BC400, SD330, BC250, PRO370, PRO400, MS3300, MS4000, MS4500	M10x1,25 LH M
	MS3300, MS4000, MS4500, MS3310, MS-4010, MS-4510	M12x1,5 LH F ST
	MS3300, MS4000, MS4500, MS3310, MS-4010, MS-4510	M12x1,5 LH F - M14x1,5 LH F
	BC225, C225, LT225, MS220, MS2300, MS2600, MS3100, LT154, NB, NB01F, NB02, NB16F, NB211, NBF171, NB26, NB31, LT225, LT255, NB2, NB271, MS-250, MS3200, MS5200, MS2810	M8x1,25 LH F
ECHO	SRM2300L, SRM2300U, SRM2090L, SRM2090U, SRM250EL, ARM400A, RM460, RMA2530, SRA2190, 250EU, SRM310, 310U, RM380, SRM302BDX, SRM3800, SRM4600, SRM2450L, 2450U, SRM3500, SRM3550, SRM2510, RM460, SRA2190, RMA2530, SRM2600L, 2600U, SRM3150L, 3150U, SRM343SL, C	M10x1,25 LH F
	CLS4600, CLS5800, CLS5810	M12x1,75 LH F HU
EFCO	8060, 8100, 8200, 8250R, STARK26TR	M8x1,25 LH F
	8250RL, 8220IC, 8260IC, STARK26IC, 8250/IC/ICD, 8300NEW, 8250ICD, 8250ICNEW, 8350/IC, 8400/IC, 8460/IC, 8530/IC, 8550BOSS, 8355, 8405, 8465, 8535	M8x1,25 LH M EFCO
	200 Series -200, 2201C, 260/D, 2601C, 2601CVA, 261/A, 300 Series 300A/AIC, 301, 310, 350, 400 Series 400/AIC, 400A, 410, 450, 460/AVS,	M8x1,25 LH M EFCO
GREEN MACHINE	1200, 1500, 1600, 1700, 1900, 2000, 2100, 2200, 2331, 2340, 2500, 3000, 3451, 4000, 4500	M8x1,25 LH M
HOMELITE	ST160, 180, 200, 210	3/8-24 UNF LH F
	BCH38, BCH40, BCH48, PBC3800, PBC4000	M10x1,25 LH F
	NBA524, PMB522, TXD508	M10x1,25 LH M
	TM523	M7x1 LH M
	HBC30, HBC30B, HBC30C, 38, 40, HK14, HK18, HK24, HK28, HK33, HK38, PCB3600, PCB3600B, PCB3600E, PLT3400, ST155, 175C, 185C, 285C, 385C, ST485, ST485C, BCH32CDI, BCH33, BCH33DI, BCH33TO, BCH33B, BCH40, BCH48	M8x1,25 LH F
	BCH20, BCH24, BCH2D, BCH32C, BCH33, BCH33B, BCH33DI, BCH33TO, ST80, ST100, ST120, ST160, ST180, ST200, ST210, ST360, ST385, SXD20, TK518, NBA524, PMB522, TXD508	M8x1,25 LH M
HONDA	UMK422LTE, UMK422UT4E, UMK422LT4E	M10x1,25 LH F
	UH41, SXD-25HE	M8x1,25 LH M EFCO
HUSQVARNA	Mondo MEGA, Mondo Maxi, 26L	3/8-24 UNF LH F
	232L, 232LCAT, 32R, 225RJ, 225R, RD, 232R, 232RCAT, 322L, 325LX/XT, 325RJX, 322RJ, 325RX/RXT	M10x1,25 LH F HU
	235RCAT, 240R, 240RBD, 250RX, 245R, 245RX, 265RX, 140R, 165R, 244R, 244GX, 36R, 39R, 16R, 18RL, 22RL, 240RJ, 142RB, 152RB, 252RX	M12x1,75 LH F HU
	24R (before 1987)	M7x1 LH M
	16R, 25R - before 1987	M8x1,25 LH M
IKRA	BT1045	M8x1,25 LH M
ISEKI/SHINDAIWA	DYB351, DYB453, DYB354, DYB454	M10x1,25 LH M
	DYB201, DYB202, DYB231, DYB232	M7x1 LH M
	IAX180, 190, 250, 350, 400, 500	M8x1,25 LH F

Guide list for nylon head adaptors

BRAND	MODEL	ADAPTOR
JONSERED	RS38	M10x1 LH F ST
	BP40COMBI, BP2040C, BR400, BR450, GR32L, GR32LCAT, GR41, GR44, GR26D, GR26L, GR26COMBI, GR2026D, GR2026L, GR2026CL, GR3032D, GR3032L, GT21, GT22, GT24, GT26D, GT26L, RS44,	M10x1,25 LH F HU
	GR32D, GR32DCAT, GR36, GR36CAT, GR41, G50, R38, R45, RS30, RS38, RS40, RS45, RS51PRO, RS52, GR2036, BP2052, BP240C	M12x1,75 LH F HU
	G25RD	M8x1,25 LH F
	LR200, LR220, LR260, LR300	M8x1,25 LH M
KAAZ	410, J40/BD/HD, J400/GX, JLKT200, JLQT200, JQ/40/50, JQG4K, K40D/BD, KQ30/NE, KT10, KT18/1S/30, KW30NE, K40D/BD, KQ30/NE, KT10/18/1S/30, KW30NE, RQ30/40, RX350/351L, TI70, 240/410, V190/35/40, V420/520, VNX540, VRX360/440/540, VX221/251C/360/360S, VX440	M10x1,25 LH F
	V20, S20	M7x1 LH M
KAAZ - IDEAL	JQ, JQ40, JQ50, VRX540, JQG4K, JQT200, KQ30, T170, T240, T410, J400GX, V25, V35, V40, VX360, K40D, K408D, S25, SX230, SX260	M8x1,25 LH F
KOMATSU ZENOAH	BC431FWM, BC531DWM, BC532DWM, BK531DL, FBC22, FBC26	M10x1,25 LH M
	BC220DL, BC221DL, BC17, BC23, BC32	M7x1 LH M
	BC254A, BC260DM, BC260DUM, BC340DWM, BC340FW, BC341DWH, BC431DWM, BC432FWM, BCD20, BCF01, BK245FLK, BK345FL, BK346FL, BK435FL, BK436FL, BK530DL	M8x1,25 LH M
MAKITA	DBC3300, DBC4000, DBC4000C	M12x1,5 LH F ST
	DBC3300, DBC4000, DBC4000C	M12x1,5LH F - M14x1,5LH F
	RBC230, RBC260, RBC310, RBC410, RBK410, RBC525	M8x1,25 LH M
MARUYAMA	23	M10x1,5 LH F HU
	BC200C, BC260, BC260H, MC260, MC260S	M10x1,25 LH F
	32, 35	M10x1,25 LH M
	BC184, BC184C, BC220DE, BC230, BC241, BC326, BC330, BC402, BC480, BC331BK, MB100, MB250, MB300, MB400, MB500	M8x1,25 LH M
MC CULLOCH	SUPERMAC26, MAC30A, 30AV, PRATER30, EUROPA92/35A, EUROPA, MS24, MS52, PROMAC38AV, BP38AV, WINDSORKIT26, VERSAILLES38, BP26AV, BP35AV	M10x1,5 LH M MC
	100A, 90/A, 95A, 99A, EB3, MAC80, MAC85A, MAC90, MAC90A, MAC95A, PS1, PS2, PS3, PS4, PS5, SEB4, SM100, SMAC30AV, SMAC38AV, SMAV38AV	M10x1,25 LH F
	TD2100, MAC32, MAC37	M10x1,25 LH M
	MAC22/23/30/38	M8x1,25 LH F
	BP30AV, DELTA, MS33, MS40, MAC22, MAC23, MAC30, S'MAC30AV, TD2400, TD3300, TD4000	M8x1,25 LH M
MURUNAKA	TM33DX/F43L, TM33DX/F43, T200DX/F43L, T200DX/F43, TM33JX, /F404L, T200JX/F404L, BC330DX, BC400DX, BK404FX	M10x1,5 LH F HU
	G13K	M10x1,25 LH F
	BC480DX, G3/5, G8K, GL3K, T240DX/F53/L, T240DX/F53	M10x1,25 LH M
	BC180DX, BC181DX, BC200DX, BC240DX, TM21DX/F3L, TM24DX/F3L	M8x1,25 LH F
NIKKARI	38, PNB522, TXD50B, NBA524, SXD40, FK514	M10x1,25 LH M
	SDX20, RK521, TDK518	M8x1,25 LH M
OLEOMAC	TR60E, TR101E, 720, SPARTA26TR, 725B,	M8x1,25 LH F
	200, 220, 260, 300, 310, 400, 410, 433BP, 440, 440BP, 722S, 726S, 726T, 727D, 727C, 727S, 727T, 733S, 733T, 740S, 740T, 750S, 750T, 8420, 85100, TR60E, TR100E, 720, 725B, SPARTA26TR	M8x1,25 LH M EFCO
PARTNER	B400	M10x1 LH F ST
	200, 203, 205, B250C, B250V(before1987), T250, B323, B325	M10x1,25 LH F HU
	B370, B380, B180, B440, B450, B405, B250C/V, B250U, B450G, B450/C, B265J, B405	M12x1,75 LH F HU

Guide list for nylon head adaptors



BRAND	MODEL	ADAPTOR
POULAN	PRO MODELS: 165, 175, 185, 195, 200, 800, 900, 2620, 2820	3/8-24 UNF LH F
	150, 200, 2620, 800, 900	M10x1,5 LH F HU
RED MAX	BC430DWM, BC440DWM	M10x1,25 LH M
	BC220DL, BC221DL	M7x1 LH M
	BC260CL, BL340DL	M8x1,25 LH M
ROBIN	IVB50L, NB03, NB04, NB411L, NB50L	M10x1 LH F ST
	BH3500, BH3600	M10x1,25 LH F
	VBK411, NB02, NB16F, NB211, NB26, NB281A, NB31, NB31AU, NB351, NBA231, NBK411, NBT415, IVBF231, NB231, NB23F, NBF171, NBF231, BH2500A	M8x1,25 LH F
	NBR30, NBR40, NB351, NB30K	M8x1,25 LH M
RYOBI	RD260	M10x1,25 LH F HU
	RD260	M10x1,5 LH F HU
	RD5224, RD5225, RSB2801, RSH1100	M10x1,25 LH M
	RD330, RD430, RD519	M12x1,75 LH F HU
	RD1605, RD2414, RD3818, RD3318	M8x1,25 LH F
	RD180K, RD180KS, RD180S, 3318, REK285BP	M8x1,25 LH M
SHINDAIWA	B35, B40, B45, BP35, C35, RC35, RC45, F18	M10x1,25 LH M
	C20/230, LT18/20, T18/20/A, T230/XR, T23E, T35	M7x1 LH M
SHINDAIWA/ISEKI	BP35, BP45, C23, C25, C27, C250, DYB251, DYB252, DYB254, DYB261, DYB262, DYB321, DYB322, F20, R20, R25, R35F, T25, T27, T250, T260, T270, T350, YARDWARE220	M8x1,25 LH M
SHINGU	PK4036DD, PK4846DD	M10x1,5 LH M MC
	200, 250, 350, S22PNC, S23PNC	M7x1 LH M
	S20, G1823E, G1823DE, G2523E, G2523DE, PK2325E, PK2326DE, PG3330DD, PK4035DD, PK4845DD, 650, P750, P850	M8x1,25 LH M
SOLO	123, 125, Multimot	M10x1 LH F ST
	100, 130S, 014, 119, 400, FS135, FS136, S100, S400	M10x1,25 LH F
	124, 126, 127, 128, 130, 134, 137, 140, 141	M12x1,5 LH F ST
	124, 126, 127, 128, 130, 134, 137, 140, 141	M12x1,5LH F - M14x1,5LH F
	FS125, S200, S300	M8x1,25 LH F
STIHL	FS44, FS52, FS56, FS66, FS86, FR106, FS74, FS74R, FE55, FS36, FS88, FR108, FS40, FS76, FS76R, FS106, FS108, FS48, FS52, FS62, FS81, FS96,	M10x1 LH F ST
	FS160, FS220, FS55/R, FS25-4/R, FS65-4/R, FS80R, FS85/R/RT	M10x1,5 LH F HU
	420, FS08, FS150/180, FS20, FS200, FS280/K, FS353AV, FS360, FS410, FS420, FR350/450, FS350/450/400K/450K, FS400/L, FS500, FS550	M12x1,5 LH F ST
	420, FS08, FS150/180, FS20, FS200, FS280/K, FS353AV, FS360, FS410, FS420, FR350/450, FS350/450/400K/450K, FS400/L, FS500, FS550	M12x1,5LH F - M14x1,5LH F
	FS50, FS51, FS60, FS61, FS65, FS80, FS80E, FS90, FS90AVE, FS96	M8x1,25 LH M
TANAKA	AST250/5000/7000, SUM250, SUM301/321/321E/351/400, SUM421/500/7000, TBC16/160/162/20/2000, SUM205/215/220/2200, TBC225-255, TCB23/232/2507250DH/262/265/265SDH/262, TBC265, TBC265SDH/30/300/322/355/37/373/4000/422/422BDH, TBC4500/500/5000/500DH/501/202, TB	M8x1,25 LH M
TAS TANAKA	SUM3	M10x1,25 LH F
	TBC162, TBC202, TBC205, TBC215, AST7000	M8x1,25 LH F
WEED EATER	1000, 609, PRO195, XR100, XR105, XR125, XR200, XR90, XR95, YP140, YP160, YP200	M10x1,5 LH F HU
	PRO37	M10x1,25 LH M
	22, 599	M8x1,25 LH M
XENOAH	FBC22, FBC26	M10x1,25 LH M
YAMAHA	YBC50D	M10x1,25 LH M
	YBC20D, YBC30D, YBC40D	M8x1,25 LH M

Whips Trimmer Head

Universal Mounting

Trimmer head, universal mounting without adaptor, centering bore for both 20-25,4 mm.
Delivered complete with: 6 nylon whips of $\varnothing = 3$ mm and length = 300mm each / kit of adaptor washers / reduction rings.
Suggested for trimmers up to 33 cc.

- Larger knob for more comfortable assembling and disassembling.

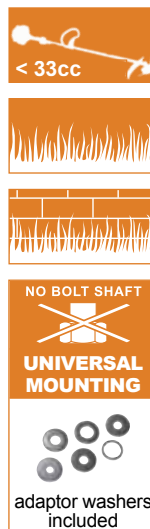

options

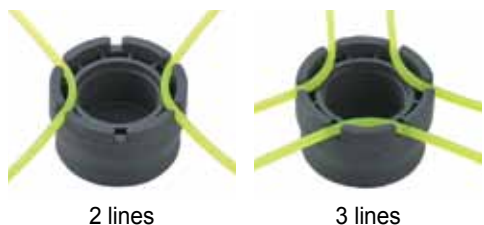

P/N	DESCRIPTION	EAN13 CODE
5090901	Nylon / Nylon head	8032706104050

PACKAGING: 1 pc x Nylon Bag		Q.TY x MASTER PACK: 50 pcs MASTER CARTON: 39x39x32 cm TOTAL WEIGHT: 9 kg	
--	--	---	--

ORDER MULTIPLES OF: 50 pcs

replacement parts

Set of nylon whips



See on the catalogue:

PAGE 100

SPARE PARTS

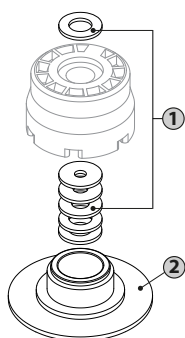

P/N	DESCRIPTION	ORDER MULTIPLES OF:
1 K00401008	Kit of adaptor washers and reduction rings	10 kits
2 5090012	Plastic knob Ø80 mm	10 pcs

PACKAGING:
Nylon Bag

Whips Trimmer Head

Universal Mounting

Professional trimmer head, universal mounting without adaptor, centering bore for both 20-25,4 mm.

- Improved overall look for display presentation.
- Easier assembling and disassembling.
- Redesigned fixed-line chamfers of lines attachment slots, reduces fixed-line strain and breakages.

Delivered complete with: 10 nylon whips of $\varnothing = 3,3$ mm and Length = 300 mm each / kit of adaptor washers / reduction rings.

Suggested for brushcutters over 33 cc.

- Larger aluminium knob for more comfortable assembling and disassembling.

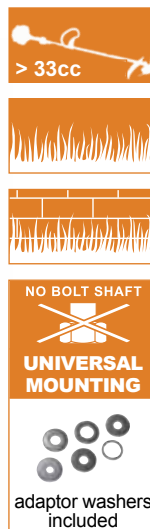

options

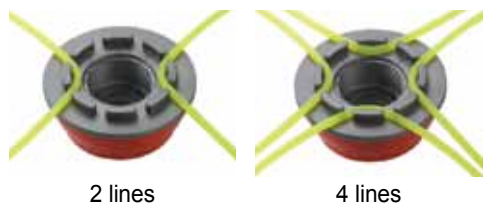

2 lines

4 lines

P/N	DESCRIPTION	EAN13 CODE
50909006	Aluminium / Aluminium head	8032706105606

PACKAGING:

1 pc x
Nylon Bag



Q.TY x MASTER PACK:

MASTER CARTON:
TOTAL WEIGHT:

50 pcs

39x39x32 cm
19 kg

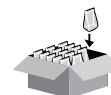

ORDER MULTIPLES OF: 50 pcs

replacement parts

Set of nylon whips



See on the catalogue:

PAGE 100

SPARE PARTS

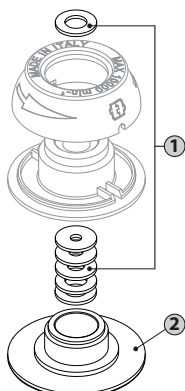

P/N	DESCRIPTION	ORDER MULTIPLES OF:
1 K00401008	Kit of adaptor washers and reduction rings	10 kits
2 5090014	Aluminium knob Ø80 mm	10 pcs
5090012	Plastic knob Ø80 mm	10 pcs

PACKAGING:
Nylon Bag



Whips 6 Trimmer Head

Universal Mounting

Professional trimmer head, universal mounting without adaptor, centering bore for both 20-25,4 mm.

- Improved overall look for display presentation.
- Easier assembling and disassembling.
- Redesigned fixed-line chamfers of lines attachment slots, reduces fixed-line strain and breakages.

Delivered complete with: 10 nylon whips of $\varnothing = 3,3$ mm and Length = 300 mm each / kit of adaptor washers / reduction rings.

Suggested for brushcutters over 33 cc.

- Larger aluminium knob for more comfortable assembling and disassembling.

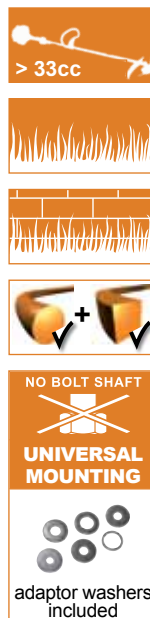

options

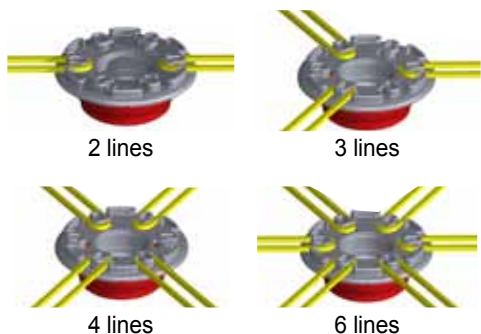

P/N	DESCRIPTION	EAN13 CODE
50909013	Aluminium / Aluminium head	8032706106061

PACKAGING: 1 pc x Nylon Bag		Q.TY x MASTER PACK: 50 pcs MASTER CARTON: 39x39x32 cm TOTAL WEIGHT: 19,5 kg	
--	--	--	--

ORDER MULTIPLES OF: 50 pcs

replacement parts

Set of nylon whips



See on the catalogue:

PAGE 100

highlights

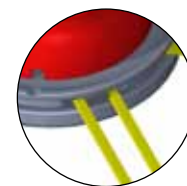
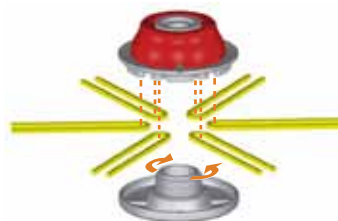

Easy and fast assembling and refilling.
Can be charged with round and square line.

Properly shaped edges to prevent line breaking.

SPARE PARTS

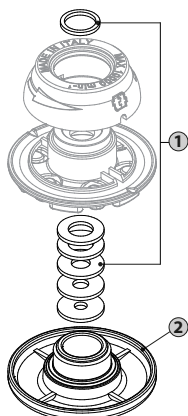

P/N	DESCRIPTION	ORDER MULTIPLES OF:
1 K00401008	Kit of adaptor washers and reduction rings	10 kits
2 K00401116	Aluminium knob Ø95 mm	10 pcs

PACKAGING:
Nylon Bag

Whips Trimmer Head

Universal Mounting

New concept nylon head. Modern design combined with high cutting performance and minimum weight. Universal mounting without adaptor, centering bore for both 20-25,4 mm. Delivered complete with: 4 nylon whips of $\varnothing = 3,3$ mm and Length = 300 mm each / kit of adaptor washers / reduction rings. Suggested for brushcutters up to 33 c.c.

► Larger knob for more comfortable assembling and disassembling.

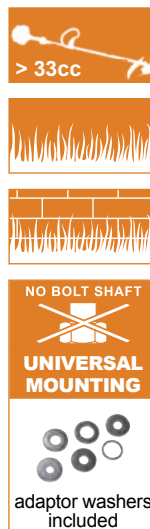

options

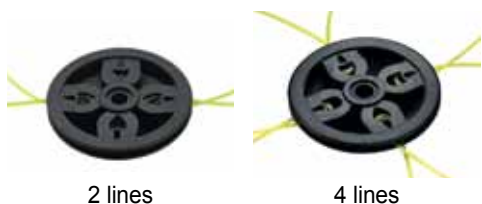

2 lines

4 lines

P/N	DESCRIPTION	EAN13 CODE
5090912	Nylon head	8032706104074

PACKAGING:	Q.TY x MASTER PACK:	50 pcs
1 pc x Nylon Bag	MASTER CARTON:	42x37x29 cm
	TOTAL WEIGHT:	12 kg

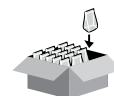

ORDER MULTIPLES OF: 50 pcs

replacement parts

Set of nylon whips



See on the catalogue:

PAGE 100

SPARE PARTS

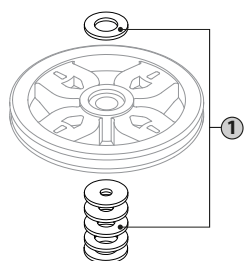

P/N	DESCRIPTION	ORDER MULTIPLES OF:
1 K00401008	Kit of adaptor washers and reduction rings	10 kits

PACKAGING:
Nylon Bag



Whips Trimmer Head

Universal Mounting

Professional trimmer head, universal mounting without adaptor, centering bore for both 20-25,4 mm. Multi stage line extension for mulching purpose.

Delivered complete with: 10 nylon whips of $\varnothing = 3,3$ mm and Length = 300 mm each / kit of adaptor washers / reduction rings.

- Improved overall look for display presentation.
- Easier assembling and disassembling.
- Redesigned fixed-line chamfers of lines attachment slots, reduces fixed-line strain and breakages.
- Larger aluminium knob for more comfortable assembling and disassembling.

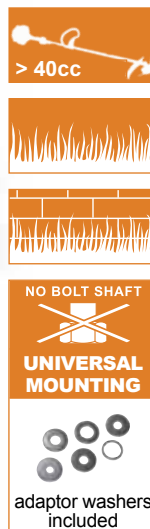
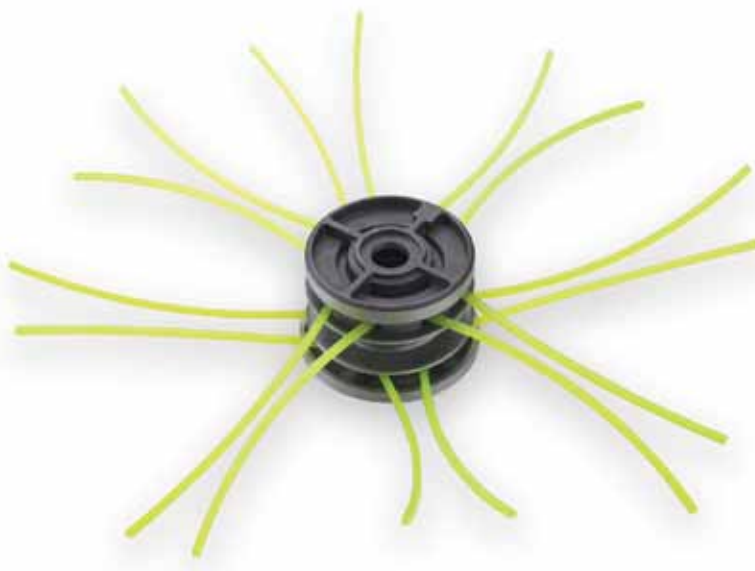

options

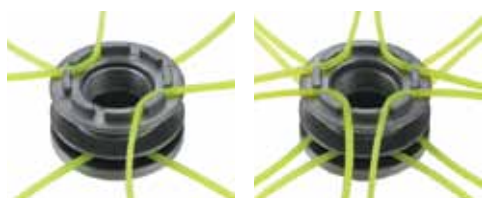

4 lines

8 lines

P/N	DESCRIPTION	EAN13 CODE
5090911	Aluminium / Aluminium head	8032706104081

PACKAGING:

1 pc x
Nylon Bag



Q.TY x MASTER PACK: 50 pcs

MASTER CARTON:

52,5x37x29 cm

TOTAL WEIGHT:

17 kg

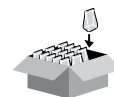

ORDER MULTIPLES OF: 50 pcs

replacement parts

Set of nylon whips



See on the catalogue:

PAGE 100

SPARE PARTS

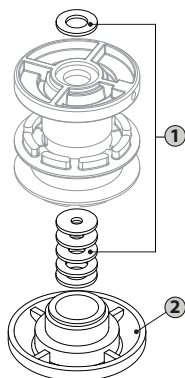

P/N	DESCRIPTION	ORDER MULTIPLES OF:
1 K00401008	Kit of adaptor washers and reduction rings	10 kits
2 5090014	Aluminium knob $\varnothing 80$ mm	10 pcs

PACKAGING:
Nylon Bag



PROWhips

Trimmer Head

Universal Mounting

Most comfortable manual head disassembling operation for easy fixed line loading. Cross-over lines ensures higher line resistance and flexibility. Centering bore for both 20-25,4 mm.

- Larger aluminium knob for more comfortable assembling and disassembling.



> 33cc

NO BOLT SHAFT

UNIVERSAL MOUNTING

adaptor washers included

options



2 lines



4 lines

replacement parts

Set of nylon whips



See on the catalogue:

PAGE 100

highlights

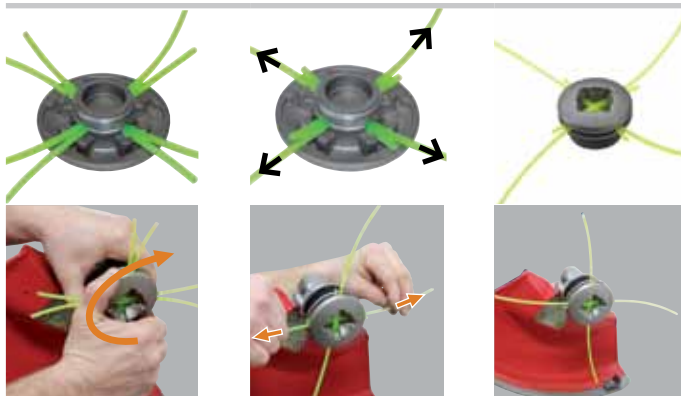

SPARE PARTS

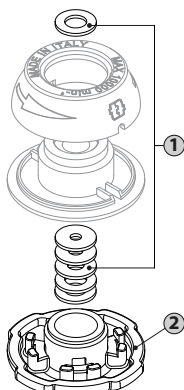

P/N	DESCRIPTION	ORDER MULTIPLES OF:
1 K00401008	Kit of adaptor washers and reduction rings	10 kits
2 C00012017	Aluminium knob Ø80 mm	10 pcs

PACKAGING:
Nylon Bag



Whips 25 Trimmer Head

Universal Mounting

5 second line change!
No tools required.
Quick and easy installation.

Wide size head for more precise grass cutting and turf care.
Patented fixed line insertion and clamping.
Easy maintenance and top results for demanding landscapers.

Complete with kit of adapter washers and reduction rings and 4 whips of Nylsaw™ Ø3,5 mm, 425 mm long.
To complete range of Nylsaw™, see pages 80-81.

Equipped with



NILSAW™ special line

NO BOLT SHAFT



UNIVERSAL MOUNTING



adaptor washers included



> 33cc

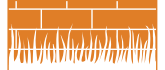

PATENT PENDING



P/N	DESCRIPTION	EAN13 CODE
50619001	Aluminium / Nylon head	8032706105163

PACKAGING:
1 pc x
Clamshell



Q.TY x MASTER PACK: 12 pcs
MASTER CARTON: 56x32,5x18 cm
TOTAL WEIGHT: 21 kg

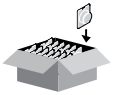

ORDER MULTIPLES OF: 12 pcs

options



2 lines

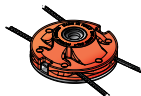

4 lines

packaging



FRONT
- EAN code
- Part No.
- Buscutter models

BACK
- Mounting instructions
- Loading instructions
- Technical data

preparation

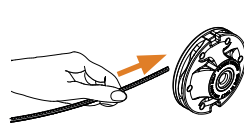

1 - For optimal results, use Nylsaw™ special whips 425 mm long.

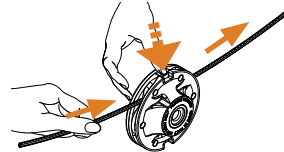

2 - Press in the lateral metal buttons and insert new pre-cut whip

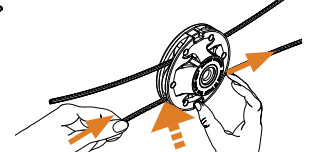

3 - Ensure that the whip is the same length of each side of the head, and beginning work!

replacement parts

P/N 05200112

Set of 25 nylon whips each, 260 mm long - Ø 3,5 mm
EAN13 CODE 8032706102353

PACKAGING: 1 SET x Plastic Tube
Q.TY x MASTER PACK: 40 Sets
MASTER CARTON: 32,5x29x16 cm



ORDER MULTIPLES OF: 40 sets

P/N 05200153

Set of 17 nylon whips each, 425 mm long - Ø 3,5 mm

PACKAGING: 1 SET x Plastic Tube
Q.TY x MASTER PACK: 63 Sets
MASTER CARTON: 51x25,5x28,5 cm



ORDER MULTIPLES OF: 63 sets



NILSAW™ special line



See on the catalogue:

PAGE 108

SPARE PARTS

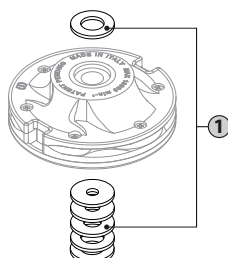

P/N	DESCRIPTION	ORDER MULTIPLES OF:
1 K00401008	Kit of adaptor washers and reduction rings	10 kits

PACKAGING:
Nylon Bag



Whips 25P Trimmer Head

Universal Mounting

5 second line change!
No tools required.
Quick and easy installation.
Fits 99% of all gas trimmers.

Wide size head for more precise grass cutting and turf care.
Patented fixed line insertion and clamping.
Easy maintenance and top results for demanding landscapers.

Complete with kit of adapter / nut / bolt / spacer and reduction rings and 4 nylon whips of $\varnothing = 3,0$ mm and Length = 300 mm each.



NO BOLT SHAFT
UNIVERSAL MOUNTING

adaptor washers included

< 33cc

> 20cc

PATENT PENDING



options



2 lines



4 lines

P/N	DESCRIPTION	EAN13 CODE
50619010	Nylon / Nylon head	8032706106085

PACKAGING: 1 pc x Nylon Bag		Q.TY x MASTER PACK: 50 pcs MASTER CARTON: 39x39x32 cm TOTAL WEIGHT: 19 kg	
--	--	--	--

ORDER MULTIPLES OF: 10 pcs

replacement parts

Set of nylon whips



See on the catalogue:
 PAGE 100

preparation

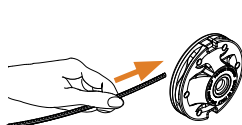

1 - For optimal results, use Nylon whips 300 mm long.

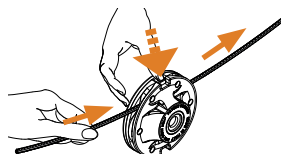

2 - Press in the lateral metal buttons and insert new pre-cut whip

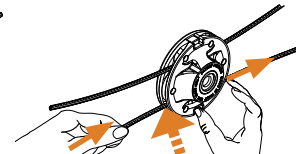

3 - Ensure that the whip is the same length of each side of the head, and beginning work!

SPARE PARTS

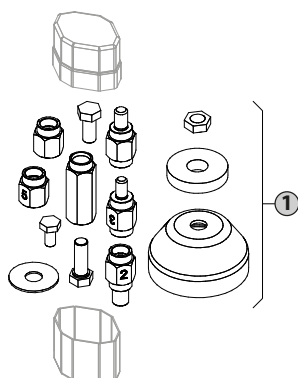

P/N	DESCRIPTION	ORDER MULTIPLES OF:
1 K00401117	Kit of adapter / nut / bolt / spacer and reduction rings	10 kits

PACKAGING:
Nylon Bag



Whips 25P

provided with following items

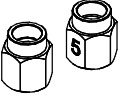
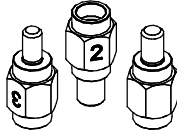
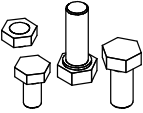
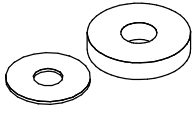
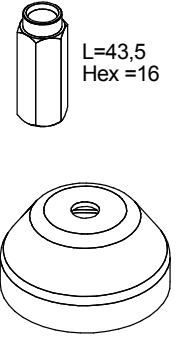
NUTS FEMALE	BOLTS MALE	HEX BOLTS MALE	WASHERS	ADAPTERS
				
M8x1 RH F 1 pc	M7x1 LH M 1 pc M10x1 LH F 1 pc	20 G 1/4" LH L=13,0 Hex =10,8 1 pc	Ø 10,5x30x1,15 mm 1 pc	L=43,5 Hex =16 1 pc
3/8-24UNF RH F 1 pc	M8x1,25 LH M 1 pc M8x1,25 LH F 1 pc	18 G 5/16" RH L=17,8 Hex=12,5 1 pc	Ø 12,5x36x7 mm 1 pc	
	M10x1,25 LH M 1 pc M10x1,25 LH F 1 pc	18 G 5/16" LH L=17,8 Hex=12,5 1 pc		
		M8x1,25 RH F 1 pc		

Whips 25P

highlights

MOUNTING METHOD 1: MOST STRAIGHT SHAFT TRIMMERS

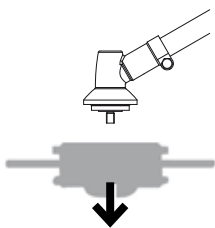

1 - Remove original head from trimmer.

NUTS FEMALE



M8x1 RH F
3/8-24 RHF
M8x1,25 LH F
M10x1 LH F
M10x1,25 LH F

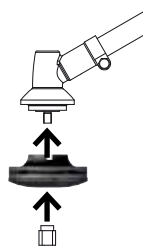

3 - Insert mounting nut (round end first) into the head.

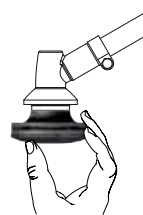

4 - Hand tighten the head to trimmer.

MOUNTING METHOD 2: MOST CURVED SHAFT TRIMMERS SHAFT TRIMMERS

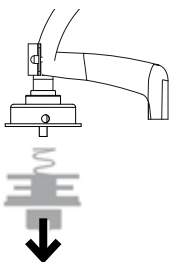

1 - Remove knob, line spool, then the spring from original trimmer head.

2a - BOLT MALE



M7x1 LH M
M8x1,25 LH M
M10x1,25 LH M

2b - HEX BOLT MALE + ADAPTER

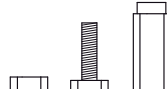

18 G 5/16" RH L=17,8 Hex =12,5
18 G 5/16" LH L=17,8 Hex=12,5
20 G 1/4" LH L=13,0 Hex =10,8
M8x1,25 RH F

2a - determine which mounting bolt fits your trimmer, or (2b) use hex bolt with the adapter.

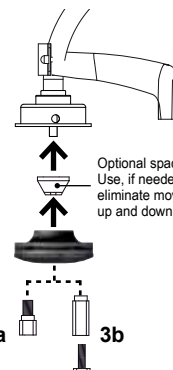

3a - insert mounting bolt into the head, or (3b) insert adapter (round end first) into the head then inser hex bolt into adapter.

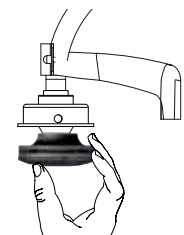



4 - Hand tighten the head to trimmer.

Replacement parts for whips trimmer heads

SQUARE nylon whips suitable to:

Whips Trimmer Head

 Page 91

Whips Trimmer Head

 Page 92

Whips 6 Trimmer Head

 Page 93

Whips Trimmer Head

 Page 94

Whips Trimmer Head

 Page 95

PROWhips Trimmer Head

 Page 96

Whips25P Trimmer Head

 Page 98

TYPE: 

QUALITY: ★★★★★ 



P/N	SQUARE	DESCRIPTION	EAN13 CODE
	mm in		
5200040	3 .119"	Set of 50 nylon whips each, 300 mm long (12")	8032706101615
5200041	3,3 .130"	Set of 50 nylon whips each, 300 mm (12") long	8032706101622

PACKAGING:
1 SET x
Nylon Bag



Q.TY x MASTER PACK: **150 sets**
 MASTER CARTON: 58x40x35 cm
 TOTAL WEIGHT: 18 kg

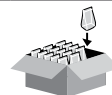

ORDER MULTIPLES OF: **150 sets**



P/N	SQUARE	DESCRIPTION	EAN13 CODE
	mm in		
05200036	3,3 .130"	Set of 50 nylon whips each, 300 mm (12") long	8032706101783

PACKAGING:
1 SET x
Clamshell



Q.TY x MASTER PACK: **50 sets**
 MASTER CARTON: 39,5x39,5x40,5 cm
 TOTAL WEIGHT: 8 kg

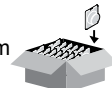

ORDER MULTIPLES OF: **50 sets**

Whips trimmer heads adaptor



Fits HU only

P/N	DESCRIPTION
5090019	Taper adaptor (fits HU only)

PACKAGING:
1 pc x
Nylon Bag



Q.TY x MASTER PACK: **10 pcs**

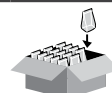

ORDER MULTIPLES OF: **10 pcs**

TRIMMERLine

ROUND Nylon Line



TYPE:



QUALITY:



Set of 50 round nylon whips, 200 mm (8") long.



P/N	ROUND Ø		EAN13 CODE
	mm	in	
05200038	2.4	.095"	8032706101714
05200039	2.7	.105"	8032706101721
05200040	3.0	.118"	8032706101738
05200041	3.3	.130"	8032706101745

PACKAGING: Nylon Bag
Q.TY x MASTER PACK: 150 pcs

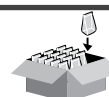

ORDER MULTIPLES OF: 150 pcs

Donut of round nylon line, 15 m long.



P/N	ROUND Ø		LENGTH	EAN13 CODE	Q.TY PER MASTER PACK	ORDER MULTIPLES OF:	TOTAL WEIGHT
	mm	in					
5200143	1.3	.050"	15	8032706101370	196 pcs	196 pcs	12 kg
5200144	1.6	.065"	15	8032706101387	196 pcs	196 pcs	15 kg
5200145	2.0	.080"	15	8032706101394	196 pcs	196 pcs	18 kg
5200146	2.4	.095"	15	8032706101400	182 pcs	182 pcs	20 kg
5200147	2.7	.105"	15	8032706101417	112 pcs	112 pcs	14 kg
5200148	3.0	.119"	15	8032706101424	112 pcs	112 pcs	16 kg
5200149	3.3	.130"	15	8032706101431	112 pcs	112 pcs	17 kg

PACKAGING: Clamshell
MASTER CARTON: 80x40x24 cm

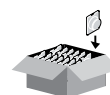

Donut of round nylon line, approx. 0,452 Kg (1 pound).



P/N	ROUND Ø		LENGTH	EAN13 CODE
	mm	in		
5200031	1.6	.065"	196	8032706100892
5200014	2.0	.080"	126	8032706100854
5200015	2.4	.095"	87	8032706100861
5200132	2.7	.105"	72	8032706101080
5200016	3.0	.119"	56	8032706100878
5200017	3.3	.130"	46	8032706100885

PACKAGING: Clamshell
Q.TY x MASTER PACK: 40 pcs
MASTER CARTON: 80x40x24 cm
TOTAL WEIGHT: 20 kg

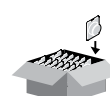

ORDER MULTIPLES OF: 40 pcs

TRIMMERLine

ROUND Nylon Line



TYPE: 

QUALITY: ★★★★★

Spool of round nylon line, approx. 0,904 Kg (2 pounds).



P/N	ROUND Ø		LENGTH	EAN13 CODE
	mm	in		
5200072	1.3	.050"	565	8032706100601
5200073	1.6	.065"	393	8032706100618
5200074	2.0	.080"	251	8032706100625

Q.TY x CARTON PALLET: 192 pcs
 CARTON PALLET: 120x80x73 cm
 TOTAL WEIGHT: 185 kg



ORDER MULTIPLES OF: 1 pc

Spool of round nylon line, approx. 1,356 (3 pounds).



P/N	ROUND Ø		LENGTH	EAN13 CODE
	mm	in		
5200191	2.0	.080"	377	8032706100489
5200192	2.4	.095"	262	8032706100496
5200193	2.7	.105"	215	8032706100502
5200236	3.0	.119"	168	8032706100533
5200194	3.3	.130"	139	8032706100519

Q.TY x CARTON PALLET: 192 pcs
 CARTON PALLET: 120x80x73 cm
 TOTAL WEIGHT: 270 kg



ORDER MULTIPLES OF: 1 pc

Spool of round nylon line, approx. 1,814 Kg (4 pounds).



P/N	ROUND Ø		LENGTH	EAN13 CODE
	mm	in		
5200070	2.0	.080"	503	8032706100229
5200046	2.4	.095"	349	8032706100151
5200071	2.7	.105"	286	8032706100236
5200047	3.0	.119"	223	8032706100168
5200048	3.3	.130"	185	8032706100175
05200141	3.5	.138"	166	8032706103701
05200143	4.0	.157"	126	8032706103732

Q.TY x CARTON PALLET: 120 pcs
 CARTON PALLET: 120x80x73 cm
 TOTAL WEIGHT: 230 kg



ORDER MULTIPLES OF: 1 pc

TRIMMERLine

ROUND Nylon Line



TYPE: 

QUALITY: ★★★★★



Spool of round nylon line, approx. **2,268 Kg** (5 pounds).

P/N	ROUND Ø		LENGTH m	EAN13 CODE
	mm	in		
5200195	2.0	.080"	629	8032706100014
5200196	2.4	.095"	437	8032706100021
5200197	2.7	.105"	356	8032706100038
5200238	3.0	.119"	279	8032706100069
5200198	3.3	.130"	232	8032706100045

Q.TY x CARTON PALLET: **120 pcs**
 CARTON PALLET: 120x80x73 cm
 TOTAL WEIGHT: 280 kg



ORDER MULTIPLES OF: 1 pc



Round nylon line delivered in spool of approx **10 Kg**.

P/N	ROUND Ø		DESCRIPTION	SPOOL WEIGHT kg	LINE PER SPOOL m
	mm	in			
5200064	1.3	.050"	1 kg of line	~ 10	~ 6610
5200065	1.6	.065"	1 kg of line	~ 10	~ 4360
5200066	2.0	.080"	1 kg of line	~ 10	~ 2790
5200003	2.4	.095"	1 kg of line	~ 10	~ 1940
5200067	2.7	.105"	1 kg of line	~ 10	~ 1590
5200004	3.0	.119"	1 kg of line	~ 10	~ 1240
5200005	3.3	.130"	1 kg of line	~ 10	~ 1030

MASTER PACK: **BULK**

ORDER MULTIPLES OF: 10 kg (1 spool)

P/N and PRICES are referred to 1 kg of line



TRIMMERLine

SQUARE Nylon Line



TYPE: 

QUALITY: ★★★★★

Set of 50 square nylon whips, 300 mm (12") long.



P/N	SQUARE <input checked="" type="checkbox"/>	EAN13 CODE
	mm in	
5200040	3.0 .119"	8032706101615
5200041	3.3 .130"	8032706101615

PACKAGING: 1 SET x Nylon Bag  **Q.TY x MASTER PACK:** 150 set
MASTER CARTON: 58x40x35 cm
TOTAL WEIGHT: 18 kg

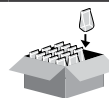

ORDER MULTIPLES OF: 150 sets

Set of 50 square nylon whips, 300 mm (12") long.



P/N	SQUARE <input checked="" type="checkbox"/>	EAN13 CODE
	mm in	
05200036	3.3 .130"	8032706101783

PACKAGING: 1 SET x Clamshell  **Q.TY x MASTER PACK:** 50 sets
MASTER CARTON: 39,5x39,5x40,5 cm
TOTAL WEIGHT: 8 kg

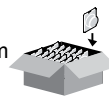

ORDER MULTIPLES OF: 50 sets

TRIMMERLine

SQUARE Nylon Line



TYPE: 

QUALITY: ★★★★★



Donut of square nylon line, **15 m** long.

P/N	SQUARE \square		LENGTH m	EAN13 CODE	Q.TY PER MASTER PACK	ORDER MULTIPLES OF:	TOTAL WEIGHT kg
	mm	in					
5200150	2.4	.095"	15	8032706101448	168 PCS	168 PCS	20 kg
5200151	2.7	.105"	15	8032706101455	112 PCS	112 PCS	15 kg
5200152	3.0	.119"	15	8032706101462	112 PCS	112 PCS	17 kg

PACKAGING: Clamshell
 MASTER CARTON: 80x40x24 cm

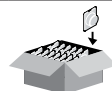

Donut of square nylon line, **approx. 0,452 Kg** (1 pound).

P/N	SQUARE \square		LENGTH m	EAN13 CODE
	mm	in		
5200062	2.4	.095"	69	8032706100922
5200118	2.7	.105"	56	8032706100946
5200035	3.0	.119"	44	8032706100908
5200036	3.3	.130"	36	8032706100915

PACKAGING: Clamshell
 Q.TY x MASTER PACK: **40 pcs**
 MASTER CARTON: 80x40x24 cm
 TOTAL WEIGHT: 22 kg

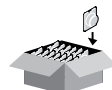

ORDER MULTIPLES OF: 40 pcs

Spool of square nylon line, **approx. 0,904 Kg** (2 pounds).

SELLING OUT



P/N	SQUARE \square		LENGTH m	EAN13 CODE
	mm	in		
5200081	2.4	.095"	137	8032706100670

Q.TY x CARTON PALLET: **192 pcs**
 CARTON PALLET: 120x80x73 cm
 TOTAL WEIGHT: 185 kg



ORDER MULTIPLES OF: 1 pc

TRIMMERLine

SQUARE Nylon Line



TYPE: 

QUALITY: ★★★★★



Spool of square nylon line, **approx. 1,808 Kg** (4 pounds).

P/N	SQUARE <input checked="" type="checkbox"/>		LENGTH m	EAN13 CODE
	mm	in		
5200080	2.4	.095"	274	8032706100243
5200085	2.7	.105"	255	8032706100250
5200049	3.0	.119"	175	8032706100182
5200050	3.3	.130"	145	8032706100199
05200137	3.5	.138"	148	8032706103756
05200139	4.0	.157"	99	8032706103770

Q.TY x CARTON PALLET: **120 pcs**
 CARTON PALLET: 120x80x73 cm
 TOTAL WEIGHT: 230 kg



ORDER MULTIPLES OF: 1 pc



Spool of square nylon line, **approx. 2,260 Kg** (5 pounds).

P/N	SQUARE <input checked="" type="checkbox"/>		LENGTH m	EAN13 CODE
	mm	in		
05200144	2.7	.105"	305	8032706103787
5200239	3.0	.119"	219	8032706100076

Q.TY x CARTON PALLET: **120 pcs**
 CARTON PALLET: 120x80x73 cm
 TOTAL WEIGHT: 280 kg



ORDER MULTIPLES OF: 1 pc



Square nylon line delivered in spool of approx. **10 Kg**.

P/N	SQUARE <input checked="" type="checkbox"/>		DESCRIPTION	SPOOL WEIGHT kg	LINE PER SPOOL m
	mm	in			
5200079	2.4	.095"	1 kg of line	~ 10 kg	~ 1520 m
5200084	2.7	.105"	1 kg of line	~ 10 kg	~ 1250 m
5200037	3.0	.119"	1 kg of line	~ 10 kg	~ 970 m
5200038	3.3	.130"	1 kg of line	~ 10 kg	~ 810 m

Q.TY x CARTON PALLET: **BULK**

ORDER MULTIPLES OF: 10 kg (1 spool)

P/N and PRICES are referred to 1 kg of line

PERFORMLine

ROUND Nylon Line



TYPE:  **HIGH DURABILITY**

QUALITY: ★★★★★

PERFORM LINE is a new concept of high performance professional line with a co-polyamide CORE that guarantees the high durability while the anti weld SKIN is abrasion and notch resistant, with a melting point at 280°C.



Donut of round nylon line, **approx. 0,452 Kg** (1 pound).

P/N	ROUND Ø		LENGTH	EAN13 CODE
	mm	in		
05200089	2.5	.099"	80	8032706102070
05200090	3.0	.119"	56	8032706102087
05200091	3.5	.138"	41	8032706102094

PACKAGING: Clamshell
Q.TY x MASTER PACK: 40 pcs
MASTER CARTON: 80x40x24 cm
TOTAL WEIGHT: 20 kg

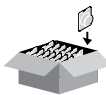

ORDER MULTIPLES OF: 40 pcs

Spool of round nylon line, **approx. 1,356 Kg** (3 pounds).



P/N	ROUND Ø		LENGTH	EAN13 CODE
	mm	in		
05200092	2.5	.099"	241	8032706102100
05200093	3.0	.119"	168	8032706102117
05200094	3.5	.138"	123	8032706102124

Q.TY x CARTON PALLET: 192 pcs
CARTON PALLET: 120x80x73 cm
TOTAL WEIGHT: 270 kg



ORDER MULTIPLES OF: 1 pc

Spool of round nylon line, **approx. 2,268 Kg** (5 pounds).



P/N	ROUND Ø		LENGTH	EAN13 CODE
	mm	in		
05200095	2.5	.099"	402	8032706102131
05200096	3.0	.119"	279	8032706102148
05200097	3.5	.138"	205	8032706102155

Q.TY x CARTON PALLET: 120 pcs
CARTON PALLET: 120x80x73 cm
TOTAL WEIGHT: 280 kg



ORDER MULTIPLES OF: 1 pc





TYPE:	
QUALITY:	★★★★★

NYLSAW™ is a “HD” (High Durability) product made in a single material with specific mechanical characteristics enabling the teeth to withstand repeated shocks and heavy use. **NYLSAW™** produce a neat cut. Thanks to the sharp teeth, **NYLSAW™** provides a clean cut and can prevent the grass from turning yellow or brown. Using **NYLSAW™** considerably reduces this symptomatic effect.



Set of **NYLSAW™** special nylon whips, **260 mm (10.4”)** long.

P/N	Ø		LENGTH	Q.TY PER SET	EAN13 CODE
	mm	in			
05200111	3.0	.119”	260	35 PCS	8032706102339
05200112	3.5	.138”	260	25 PCS	8032706102353
05200113	4.0	.158”	260	20 PCS	8032706102452
05200114	4.5	.178”	260	15 PCS	8032706102360

PACKAGING: 1 SET x Palstic Tube
Q.TY x MASTER PACK: **40 tubes**
MASTER CARTON: 32,5x28,7x15,6 cm
TOTAL WEIGHT: 5,4 kg

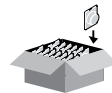

ORDER MULTIPLES OF: 40 sets



Set of **NYLSAW™** special nylon whips, **425 mm (17”)** long.

P/N	Ø		LENGTH	Q.TY PER SET
	mm	in		
05200153	3.5	.138”	425	17 PCS

PACKAGING: 1 SET x Palstic Tube
Q.TY x MASTER PACK: **63 sets**
MASTER CARTON: 51,1x25,5x28,5 cm
TOTAL WEIGHT: 6,0 kg

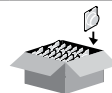

ORDER MULTIPLES OF: 63 sets



TYPE:



QUALITY:



NYLSAW™ is a “HD” (High Durability) product made in a single material with specific mechanical characteristics enabling the teeth to withstand repeated shocks and heavy use. **NYLSAW™** produce a neat cut. Thanks to the sharp teeth, **NYLSAW™** provides a clean cut and can prevent the grass from turning yellow or brown. Using **NYLSAW™** considerably reduces this symptomatic effect.

Donut of **NYLSAW™** special nylon line, **approx. 0,452 Kg** (1 pound).



P/N	Ø	LENGTH	EAN13 CODE
	mm in	m	
05200115	3.0 .119"	37	8032706102377
05200116	3.5 .138"	27	8032706102384
05200117	4.0 .158"	21	8032706102391
05200118	4.5 .178"	16	8032706102407

PACKAGING: Clamshell
Q.TY x MASTER PACK: 50 pcs
MASTER CARTON: 79,2x38,7x23 cm
TOTAL WEIGHT: 24,0 kg

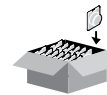

CARTONS x PALLET: 12 Cartons



ORDER MULTIPLES OF: 50 pcS

Spool of round nylon line, **approx. 1,2 Kg** (2,7 pounds). of **NYLSAW™** special nylon line.



P/N	Ø	LENGTH	EAN13 CODE
	mm in	m	
05200119	3.0 .119"	132	8032706102414
05200120	3.5 .138"	97	8032706102421
05200121	4.0 .158"	74	8032706102438
05200122	4.5 .178"	58	8032706102445

Q.TY x CARTON PALLET: 192 pcs
CARTON PALLET: 120x80x73 cm
TOTAL WEIGHT: 233,0 kg



ORDER MULTIPLES OF: 1 pc

SMARTLine

HELICOIDAL Nylon Line



TYPE:  **LOW NOISE**

QUALITY: ★★★★★

SMART LINE is a premium quality low noise monofilament, it keeps the full features of the "TRIMMER LINE" with two more:

- additional low noise (below 100 dB at 5.500 RPM).
- low petrol/electricity consumption (approx. 20%).

Donut of helicoidal nylon line, **15 m** long.



P/N	HELICOIDAL Ø		LENGTH m	EAN13 CODE	Q.TY PER MASTER PACK	ORDER MULTIPLES OF:	TOTAL WEIGHT kg
	mm	in					
05200079	1.6	.065"	15	8032706101974	196 PCS	196 PCS	15
05200080	2.0	.080"	15	8032706101981	196 PCS	196 PCS	18
05200081	2.4	.095"	15	8032706101998	182 PCS	182 PCS	20
05200082	2.7	.105"	15	8032706102001	112 PCS	112 PCS	14
05200083	3.0	.119"	15	8032706102018	112 PCS	112 PCS	16

PACKAGING: Clamshell
MASTER CARTON: 80x40x24 cm

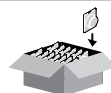

Donut of helicoidal nylon line, **approx. 0,452 Kg** (1 pound).



P/N	HELICOIDAL Ø		LENGTH m	EAN13 CODE
	mm	in		
05200084	1.6	.065"	194	8032706102025
05200085	2.0	.080"	124	8032706102032
05200086	2.4	.095"	86	8032706102049
05200087	2.7	.105"	71	8032706102056
05200088	3.0	.119"	55	8032706102063

PACKAGING: Clamshell
Q.TY x MASTER PACK: **40 pcs**
MASTER CARTON: 80x40x24 cm
TOTAL WEIGHT: 20 kg

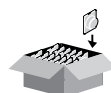

ORDER MULTIPLES OF: 40 pcs

Spool of helicoidal nylon line, **approx. 1,356 Kg** (3 pounds).



P/N	HELICOIDAL Ø		LENGTH m	EAN13 CODE
	mm	in		
05200132	2.4	.095"	264	8032706102537
05200133	2.7	.105"	216	8032706102544
05200134	3.0	.119"	169	8032706102551

Q.TY x CARTON PALLET: **192 pcs**
CARTON PALLET: 120x80x73 cm
TOTAL WEIGHT: 270 kg



ORDER MULTIPLES OF: 1 pc

PROTrim

disk with nylon blades



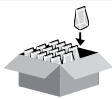

Universal disk with three (3) nylon blades, cutting diameter 230 ÷ 300 mm, universal mounting without adaptor, centering hole for both 20 ÷ 25.4 mm. Delivered complete with kit of adaptor washers.

P/N	DESCRIPTION	CUTTING Ø mm
5025901	Pro-trim disk Universal Mounting	230
5020937	Pro-trim disk Universal Mounting	300

PACKAGING: 1 pc x Nylon Bag  Q.TY x MASTER PACK: 40 pcs
 MASTER CARTON: 58x40x35 cm
 TOTAL WEIGHT: 16,5 kg 

ORDER MULTIPLES OF: 40 pcs

P/N	DESCRIPTION	CUTTING Ø mm
5020909	Pro-trim disk NEUTRAL Delivered without adaptor adaptor	255
5020919	Pro-trim disk NEUTRAL Delivered without adaptor adaptor	300

PACKAGING: 1 pc x Nylon Bag  Q.TY x MASTER PACK: 40 pcs
 MASTER CARTON: 41,5x41,5x42 cm
 TOTAL WEIGHT: 17,5 kg 

ORDER MULTIPLES OF: 40 pcs

SPARE PARTS

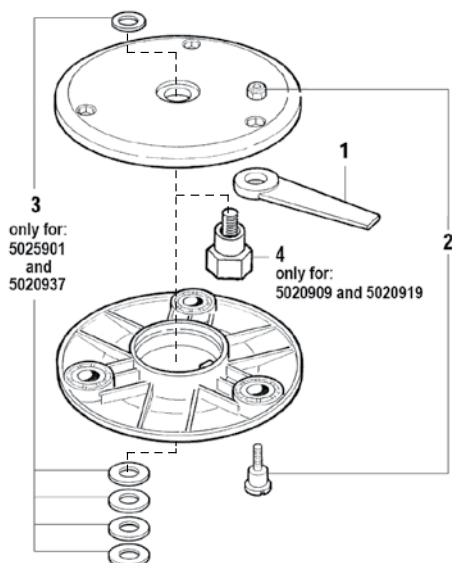

P/N	DESCRIPTION	ORDER MULTIPLES OF:
1 5020016	Nylon blade-short - L=67,5 mm (cutting Ø230 mm)	420 PCS
5020017	Nylon blade-long - L=90mm (cutting Ø300 mm)	420 PCS
2 K00401032	Complete pin and nut	10 PCS
3 K00401008	Kit of adaptor washers and reduction rings	10 kits
4 I00003002	Adaptor M 8 x 1.25 LH. M. (fits EMAK only)	10 PCS
5070011	Adaptor M 8 x 1.25 LH. F.	10 PCS
5070020	Adaptor M 8 x 1.25 LH. M.	10 PCS
5070026	Adaptor M 10 x 1.00 LH. F. (fits ST only)	10 PCS
5070008	Adaptor M 10 x 1.25 LH. F.	10 PCS
5070024	Adaptor M 10 x 1.25 LH. F. (fits HU only)	10 PCS
5070009	Adaptor M 10 x 1.25 LH. M.	10 PCS
5070027	Adaptor M 10 x 1.50 LH. M. (fits MC only)	10 PCS
5070032	Adaptor M 10 x 1.50 LH. F. (fits HU only)	10 PCS
I00003001	Adaptor M 12 x 1.25 LH. F. (fits ZE only)	10 PCS
5070010	Adaptor M 12 x 1.50 LH. F.	10 PCS
5070028	Adaptor M 12 x 1.75 LH. F. (fits HU only)	10 PCS
5070039	Adaptor M 14 x 1.50 LH. F. (fits ST only)	10 PCS

PACKAGING: Nylon Bag 

PRODisc

Trimmer Head

Universal Mounting

Trimmer head evolution:
One swing blade head for four different purposes.

Centering bore for both 20-25,4 mm

- Worm shaped blade: handy and resistant
- Larger knob for more comfortable assembling and disassembling.

Delivered complete with: 4 worm shaped blades and kit of adaptor washers.

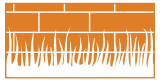

► highlights



Easy and fast assembling and disassembling

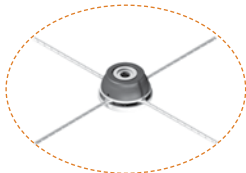

Cut diameter:
Ø 380 mm / Ø 420 mm

P/N	DESCRIPTION	CUTTING Ø mm	EAN13 CODE
50259000	Aluminium / Aluminium head	380	8032706104111
50259004	Aluminium / Aluminium head	420	8032706104128

PACKAGING:
1 pc x
Nylon Bag



Q.TY x MASTER PACK: 50 pcs
MASTER CARTON: 39,5x39x32 cm
TOTAL WEIGHT: 19 kg

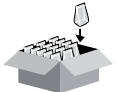

ORDER MULTIPLES OF: 50 pcs

► replacement parts

P/N 05220000

Set of 16 PCS worm shaped blade L = 150mm

EAN13 CODE 8032706103855

PACKAGING: 1 SET x Nylon Bag

Q.TY x MASTER PACK: 50 sets

MASTER CARTON: 57x39x34 cm

TOTAL WEIGHT: 4,0 kg

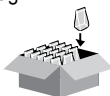

ORDER MULTIPLES OF: 50 sets

P/N 05220001

Set of 16 PCS worm shaped blade L = 170mm

EAN13 CODE 8032706103862

PACKAGING: 1 SET x Nylon Bag

Q.TY x MASTER PACK: 50 sets

MASTER CARTON: 57x39x34 cm

TOTAL WEIGHT: 5,6 kg

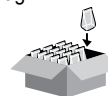

ORDER MULTIPLES OF: 50 sets



► SPARE PARTS

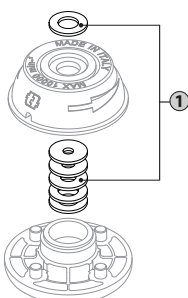

P/N	DESCRIPTION	ORDER MULTIPLES OF:
1 K00401008	Kit of adaptor washers and reduction rings	10 kits

PACKAGING:
Nylon Bag



Nylon Blades



3 teeth nylon blade.

P/N	TEETH	OUTSIDE Ø		HOLE Ø	
		mm	in	mm	in
5010013	3	250	9,8"	25,4	1"

PACKAGING: Carton Box
 Q.TY x MASTER PACK: 40 pcs
 MASTER CARTON: 24x24x24 cm
 TOTAL WEIGHT: 3,5 kg



ORDER MULTIPLES OF: 40 pcs



4 teeth nylon blade.

P/N	TEETH	OUTSIDE Ø		HOLE Ø	
		mm	in	mm	in
5010004	4	230	9"	25,4	1"
5010005	4	255	10"	25,4	1"

PACKAGING: Carton Box
 Q.TY x MASTER PACK: 50 pcs
 MASTER CARTON: 24x24x24 cm
 TOTAL WEIGHT: 4 kg



ORDER MULTIPLES OF: 50 pcs



8 teeth nylon blade.

P/N	TEETH	OUTSIDE Ø		HOLE Ø	
		mm	in	mm	in
5010002	8	220	9"	25,4	1"

PACKAGING: Carton Box
 Q.TY x MASTER PACK: 50 pcs
 MASTER CARTON: 24x24x24 cm
 TOTAL WEIGHT: 5,5 kg



ORDER MULTIPLES OF: 50 pcs

Steel Blades



2 teeth professional steel blade.

P/N	TEETH	OUTSIDE Ø		HOLE Ø		THICKNESS		EAN13 CODE
		mm	in	mm	in	mm	in	
05001013	2	300	11,8"	20,0	.78"	3,0	.12"	8032706103138

PACKAGING: Clamshell
Q.TY x MASTER PACK: 50 pcs

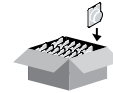

TOTAL WEIGHT: 26 kg

ORDER MULTIPLES OF: 50 pcs



2 teeth professional steel blade.

P/N	TEETH	OUTSIDE Ø		HOLE Ø		THICKNESS		EAN13 CODE
		mm	in	mm	in	mm	in	
05001015	2	255	10"	25,4	1"	1,6	.06"	8032706103152
05001016	2	305	12"	25,4	1"	1,6	.06"	8032706103169

PACKAGING: Clamshell
Q.TY x MASTER PACK: 50 pcs

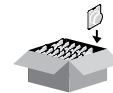

TOTAL WEIGHT: 15,5 kg

ORDER MULTIPLES OF: 50 pcs



3 teeth professional steel blade.

P/N	TEETH	OUTSIDE Ø		HOLE Ø		THICKNESS		EAN13 CODE
		mm	in	mm	in	mm	in	
05001017	3	250	9.8"	25,4	1"	2,0	.08"	8032706103176

PACKAGING: Clamshell
Q.TY x MASTER PACK: 50 pcs

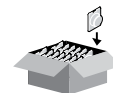

TOTAL WEIGHT: 21,5 kg

ORDER MULTIPLES OF: 50 pcs

Steel Blades



3 teeth professional steel blade.

P/N	TEETH	OUTSIDE Ø		HOLE Ø		THICKNESS		EAN13 CODE
		mm	in	mm	in	mm	in	
05001018	3	230	9"	25,4	1"	1,4	.06"	8032706103183
05001019	3	255	10"	25,4	1"	1,4	.06"	8032706103190

PACKAGING: Clamshell
Q.TY x MASTER PACK: 50 pcs

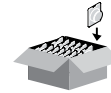

TOTAL WEIGHT: 17,5 kg

ORDER MULTIPLES OF: 50 pcs



4 teeth professional steel blade.

P/N	TEETH	OUTSIDE Ø		HOLE Ø		THICKNESS		EAN13 CODE
		mm	in	mm	in	mm	in	
05001020	4	230	9"	25,4	1"	1,4	.06"	8032706103206
05001021	4	255	10"	25,4	1"	1,4	.06"	8032706103213

PACKAGING: Clamshell
Q.TY x MASTER PACK: 50 pcs
MASTER CARTON: 36x33x23 cm
TOTAL WEIGHT: 22,5 kg

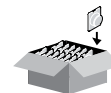

ORDER MULTIPLES OF: 50 pcs



8 teeth professional steel blade.

P/N	TEETH	OUTSIDE Ø		HOLE Ø		THICKNESS		EAN13 CODE
		mm	in	mm	in	mm	in	
05001022	8	230	9"	25,4	1"	1,4	.06"	8032706103220
05001023	8	255	10"	25,4	1"	1,4	.06"	8032706103237

PACKAGING: Clamshell
Q.TY x MASTER PACK: 50 pcs

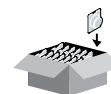

TOTAL WEIGHT: 27 kg

ORDER MULTIPLES OF: 50 pcs

Steel Blades



2 teeth-**mulching** purpose bent blades.

P/N	TEETH	OUTSIDE Ø		HOLE Ø		THICKNESS		EAN13 CODE
		mm	in	mm	in	mm	in	
05001027	2	305	12"	25,4	1"	3,0	.12"	8032706103275

PACKAGING: **Clamshell**
Q.TY x MASTER PACK: **50 pcs**



TOTAL WEIGHT: 25 kg

ORDER MULTIPLES OF: 50 pcs



3 teeth-**mulching** purpose bent blades.

P/N	TEETH	OUTSIDE Ø		HOLE Ø		THICKNESS		EAN13 CODE
		mm	in	mm	in	mm	in	
05001028	3	300	11.8"	20	.78"	3,0	.12"	8032706103282
05001029	3	300	11.8"	25,4	1"	3,0	.12"	8032706103299

PACKAGING: **Clamshell**
Q.TY x MASTER PACK: **25 pcs**

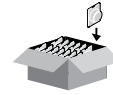

TOTAL WEIGHT: 31,5 kg

ORDER MULTIPLES OF: 25 pcs



3 teeth professional steel blade.

P/N	TEETH	OUTSIDE Ø		HOLE Ø		THICKNESS		EAN13 CODE
		mm	in	mm	in	mm	in	
05001030	3	255	10"	25,4	1"	3,0	.12"	8032706103305
05001031	3	305	12"	25,4	1"	3,0	.12"	8032706103312
05001032	3	305	12"	20	.78"	3,0	.12"	8032706103329

PACKAGING: **Clamshell**
Q.TY x MASTER PACK: **25 pcs**

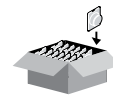

TOTAL WEIGHT: 14 kg

ORDER MULTIPLES OF: 25 pcs

Steel Blades



Chisel profile tooth to be ground with flat file holder P/N 1012962

Teeth to be set with chisel gauge setting P/N 10829011



22 teeth professional steel blades.

P/N	TEETH	OUTSIDE Ø		HOLE Ø		THICKNESS		EAN13 CODE
		mm	in	mm	in	mm	in	
05001038	22	225	8.9"	20	.78"	1,8	.07"	8032706103381
05001039	22	225	8.9"	25,4	1"	1,8	.07"	8032706103398

PACKAGING: Clamshell
Q.TY x MASTER PACK: 25 pcs

TOTAL WEIGHT: 14,5 kg

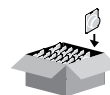

ORDER MULTIPLES OF: 25 pcs

22 / 24 / 26 teeth professional steel blades..

P/N	TEETH	OUTSIDE Ø		HOLE Ø		THICKNESS		EAN13 CODE
		mm	in	mm	in	mm	in	
05001040	22	200	7.9"	20	.78"	1,6	.06"	8032706103404
05001041	22	200	7.9"	25,4	1"	1,6	.06"	8032706103411
05001043	24	230	9"	25,4	1"	1,8	.07"	8032706103435
05001044	26	250	9.8"	25,4	1"	1,8	.07"	8032706103442
05001045	26	250	9.8"	20	.78"	1,8	.07"	8032706103459

PACKAGING: Clamshell
Q.TY x MASTER PACK: 25 pcs

TOTAL WEIGHT: 14 kg

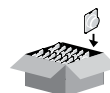

ORDER MULTIPLES OF: 25 pcs

60 / 80 teeth professional steel blades.

P/N	TEETH	OUTSIDE Ø		HOLE Ø		THICKNESS		EAN13 CODE
		mm	in	mm	in	mm	in	
05001046	60	230	9"	25,4	1"	1,4	.06"	8032706103466
05001048	80	255	10"	25,4	1"	1,4	.06"	8032706103480
05001049	80	255	10"	20	.78"	1,4	.06"	8032706103497

PACKAGING: Clamshell
Q.TY x MASTER PACK: 25 pcs
MASTER CARTON: 32,5x31x13 cm
TOTAL WEIGHT: 14 kg

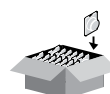

ORDER MULTIPLES OF: 25 pcs



Chisel profile tooth to be ground with flat file holder P/N 1012962

Teeth to be set with chisel gauge setting P/N 10829011



Professional Steel Blades



2 teeth professional steel blade.

P/N	TEETH	OUTSIDE Ø		HOLE Ø		THICKNESS	
		mm	in	mm	in	mm	in
5001002	2	255	10"	25,4	1"	1,6	.06"
5001003	2	305	12"	25,4	1"	1,6	.06"

PACKAGING: Carton Box

Q.TY x MASTER PACK: 50 pcs



TOTAL WEIGHT: 14 kg

ORDER MULTIPLES OF: 50 pcs



3 teeth professional steel blade.

P/N	TEETH	OUTSIDE Ø		HOLE Ø		THICKNESS	
		mm	in	mm	in	mm	in
05001008	3	250	9.8"	25,4	1"	2,0	.08"

PACKAGING: Carton Box

Q.TY x MASTER PACK: 50 pcs



TOTAL WEIGHT: 19,5 kg

ORDER MULTIPLES OF: 50 pcs



3 teeth professional steel blade.

P/N	TEETH	OUTSIDE Ø		HOLE Ø		THICKNESS	
		mm	in	mm	in	mm	in
5001004	3	230	9"	25,4	1"	1,4	.06"
5001005	3	255	10"	25,4	1"	1,4	.06"

PACKAGING: Carton Box

Q.TY x MASTER PACK: 50 pcs

MASTER CARTON: 26,5x26,5x11 cm

TOTAL WEIGHT: 17 kg



ORDER MULTIPLES OF: 50 pcs

Professional Steel Blades



4 teeth professional steel blade.

P/N	TEETH	OUTSIDE Ø		HOLE Ø		THICKNESS	
		mm	in	mm	in	mm	in
5001007	4	230	9"	25,4	1"	1,4	.06"
5001008	4	255	10"	25,4	1"	1,4	.06"

PACKAGING: Carton Box
Q.TY x MASTER PACK: 50 pcs



TOTAL WEIGHT: 19,5 kg

ORDER MULTIPLES OF: 50 pcs



8 teeth professional steel blade.

P/N	TEETH	OUTSIDE Ø		HOLE Ø		THICKNESS	
		mm	in	mm	in	mm	in
5001010	8	230	9"	25,4	1"	1,4	.06"
5001011	8	255	10"	25,4	1"	1,4	.06"
5001038	8	255	10"	20	.78"	1,4	.06"

PACKAGING: Carton Box
Q.TY x MASTER PACK: 40 pcs
MASTER CARTON: 26,5x26,5x11 cm
TOTAL WEIGHT: 31,5 kg



ORDER MULTIPLES OF: 40 pcs



2 teeth-mulching purpose bent blades.

P/N	TEETH	OUTSIDE Ø		HOLE Ø		THICKNESS	
		mm	in	mm	in	mm	in
5001029	2	305	12"	20	.78"	4,0	.16"
5001028	2	305	12"	25,4	1"	3,0	.12"

PACKAGING: Carton Box
Q.TY x MASTER PACK: 50 pcs
MASTER CARTON: 33x33x20 cm
TOTAL WEIGHT: 22 kg



ORDER MULTIPLES OF: 50 pcs

Professional Steel Blades



3 teeth-**mulching** purpose bent blades.

P/N	TEETH	OUTSIDE Ø		HOLE Ø		THICKNESS	
		mm	in	mm	in	mm	in
05001005	3	300	11.8"	20	.78"	3,0	.12"
05001006	3	300	11.8"	25,4	1"	3,0	.12"

PACKAGING: **Carton Box**
 Q.TY x MASTER PACK: **20 pcs**



TOTAL WEIGHT: 12 kg

ORDER MULTIPLES OF: **20 pcs**



3 teeth professional steel blade.

P/N	TEETH	OUTSIDE Ø		HOLE Ø		THICKNESS	
		mm	in	mm	in	mm	in
5001022	3	255	10"	25,4	1"	3,0	.12"
5001023	3	305	12"	25,4	1"	3,0	.12"
5001030	3	305	12"	20	.78"	3,0	.12"

PACKAGING: **Carton Box**
 Q.TY x MASTER PACK: **25 pcs**
 MASTER CARTON: 26,5x26,5x11 cm
 TOTAL WEIGHT: 11 kg



ORDER MULTIPLES OF: **25 pcs**



3 teeth professional steel blade.

P/N	TEETH	OUTSIDE Ø		HOLE Ø		THICKNESS	
		mm	in	mm	in	mm	in
05001009	3	300	11.8"	20	.78"	2,25	.09"
05001010	3	300	11.8"	25,4	1"	2,25	.09"

PACKAGING: **Carton Box**
 Q.TY x MASTER PACK: **50 pcs**
 MASTER CARTON: 24x24x11 cm
 TOTAL WEIGHT: 23 kg



ORDER MULTIPLES OF: **50 pcs**

Professional Steel Blades



Teeth to be set with chisel gauge setting P/N 10829011

10 and 12 teeth professional steel blades.

P/N	TEETH	OUTSIDE Ø		HOLE Ø		THICKNESS	
		mm	in	mm	in	mm	in
05001011	10	255	10"	25,4	1"	2,0	.08"
05001012	12	255	10"	25,4	1"	2,0	.08"

PACKAGING: Carton Box
 Q.TY x MASTER PACK: 40 pcs
 MASTER CARTON: 27x27x11 cm
 TOTAL WEIGHT: 29 kg



ORDER MULTIPLES OF: 40 pcs



Teeth to be set with chisel gauge setting P/N 10829011

20 teeth new design tooth profile blade for most efficient clearing operations reversible and thus high cost competitive. Professional steel blade.

P/N	TEETH	OUTSIDE Ø		HOLE Ø		THICKNESS	
		mm	in	mm	in	mm	in
05001007	20	255	10"	25,4	1"	2,0	.08"

PACKAGING: Carton Box
 Q.TY x MASTER PACK: 35 pcs
 TOTAL WEIGHT: 23,5 kg



ORDER MULTIPLES OF: 35 pcs



Chisel profile tooth to be ground with flat file holder P/N 1012962

Teeth to be set with chisel gauge setting P/N 10829011

22 teeth professional steel blades..

P/N	TEETH	OUTSIDE Ø		HOLE Ø		THICKNESS	
		mm	in	mm	in	mm	in
5001041	22	225	8.9"	20	.78"	1,8	.07"
5001042	22	225	8.9"	25,4	1"	1,8	.07"

PACKAGING: Carton Box
 Q.TY x MASTER PACK: 25 pcs
 MASTER CARTON: 27x27x11 cm
 TOTAL WEIGHT: 13,5 kg



ORDER MULTIPLES OF: 25 pcs

Professional Steel Blades



Chisel profile tooth to be ground with flat file holder P/N 1012962

Teeth to be set with chisel gauge setting P/N 10829011



22 / 24 / 26 teeth professional steel blades..

P/N	TEETH	OUTSIDE Ø		HOLE Ø		THICKNESS	
		mm	in	mm	in	mm	in
05001000	22	200	7.9"	20	.78"	1,6	.06"
05001001	22	200	7.9"	25,4	1"	1,6	.06"
05001002	24	230	9"	20	.78"	1,8	.07"
5001035	26	250	9.8"	25,4	1"	1,8	.07"
5001036	26	250	9.8"	20	.78"	1,8	.07"

PACKAGING: Carton Box
 Q.TY x MASTER PACK: 40 pcs
 MASTER CARTON: 24x24x12 cm
 TOTAL WEIGHT: 21 kg



ORDER MULTIPLES OF: 40 pcs



Teeth to be set with chisel gauge setting P/N 10829011



60 / 80 teeth professional steel blades.

P/N	TEETH	OUTSIDE Ø		HOLE Ø		THICKNESS	
		mm	in	mm	in	mm	in
5001013	60	230	9"	25,4	1"	1,4	.06"
5001039	60	230	9"	20	.78"	1,4	.06"
5001014	80	255	10"	25,4	1"	1,4	.06"
5001040	80	255	10"	20	.78"	1,4	.06"

PACKAGING: Carton Box
 Q.TY x MASTER PACK: 40 pcs
 MASTER CARTON: 27x27x12 cm
 TOTAL WEIGHT: 23 kg





ORDER MULTIPLES OF: 40 pcs

Manual Set Gauge

Manual set gauge, for correct chisel blade gauge setting.



P/N	DESCRIPTION	BLADE THICKNESS		EAN13 CODE
		mm	in	
10829011	Set gauge	1,6 ÷ 2,0	.06" ÷ .08"	8032706105019
PACKAGING:				
1 pc x		Q.TY x MASTER PACK:		24 pcs
Clamshell		MASTER CARTON:		46x35x17 cm
		TOTAL WEIGHT:		8 kg
				
ORDER MULTIPLES OF: 24 pcs				

► Packaging



► highlights



SUITABLE TO MOST COMMON STEEL BLADES

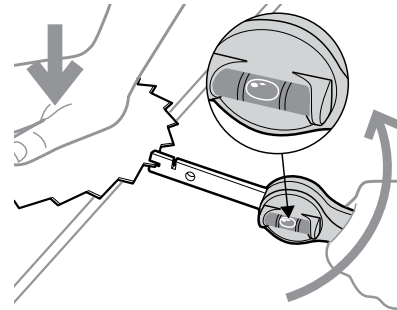
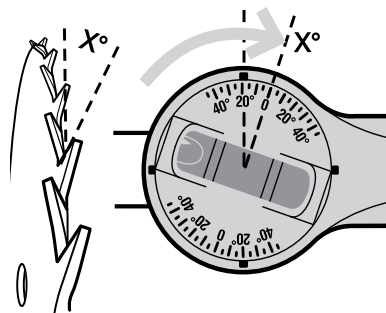
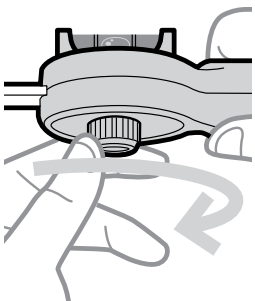



EASY TO SET END USE

Professional Face Shields



Professional face screen with metal net shield. Heavy duty adjustable face screen with ear muffs for professional demand. SNR: 30dB.

P/N	DESCRIPTION	SCREEN DIMENSIONS		EAN13 CODE
		Width mm	Height mm	
5120915	"Pro" face screen Metal net shield	370	190	8032706104517

PACKAGING: 2 pcs x Carton Box  Q.TY x MASTER PACK: 16 pcs
 MASTER CARTON: 51,5x39x43,5 cm
 TOTAL WEIGHT: 10 kg 



ORDER MULTIPLES OF: 16 pcs

certifications

 SCREEN EN 1731-S
 MUFFS EN 352-1

Heavy duty type. Adjustable, with metal net shield. Highest safety and comfort. Extra large shield.

P/N	DESCRIPTION	SCREEN DIMENSIONS		EAN13 CODE
		Width mm	Height mm	
5120912	"Pro" face screen Metal net shield	370	190	8032706104531

PACKAGING: 2 pcs x Carton Box  Q.TY x MASTER PACK: 12 pcs
 MASTER CARTON: 42,5x28,5x36,5 cm
 TOTAL WEIGHT: 4 kg 

ORDER MULTIPLES OF: 12 pcs

certifications

 SCREEN EN 1731-S

SPARE PARTS



P/N	DESCRIPTION	ORDER MULTIPLES OF:
1 1093046	Screen net shield	1 pc
2 1093073	Kit screw and lock-ring	1 pc

PACKAGING:
Nylon Bag 

Professional Face Shields



Professional face screen with polycarbonate shield. Heavy duty adjustable face screen with ear muffs for professional demand. SNR: 30dB.

P/N	DESCRIPTION	SCREEN DIMENSIONS			EAN13 CODE
		Width mm	Height mm	Thick. mm	
5120916	"Pro" face screen Polycarbonate shield	450	190	0,8+1	8032706104524

PACKAGING: 2 pcs x Carton Box
 Q.TY x MASTER PACK: 16 pcs
 MASTER CARTON: 51,5x39x43,5 cm
 TOTAL WEIGHT: 10 kg

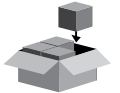

ORDER MULTIPLES OF: 16 pcs

certifications

CE SCREEN EN 166-B
 MUFFS EN 352-1



Heavy duty type. Adjustable, with metal net shield. Highest safety and comfort. Extra large shield.

P/N	DESCRIPTION	SCREEN DIMENSIONS			EAN13 CODE
		Width mm	Height mm	Thick. mm	
5120913	"Pro" face screen Polycarbonate shield	450	190	0,8+1	8032706104548

PACKAGING: 2 pcs x Carton Box
 Q.TY x MASTER PACK: 12 pcs
 MASTER CARTON: 42,5x28,5x36,5 cm
 TOTAL WEIGHT: 4 kg

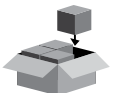

ORDER MULTIPLES OF: 12 pcs

certifications

CE SCREEN EN 166-B

SPARE PARTS



P/N	DESCRIPTION	ORDER MULTIPLES OF:
1 1093045	Screen polycarbonate shield	1 pc
2 1093073	Kit screw and lock-ring	1 pc

PACKAGING:
Nylon Bag



Face Shields



Adjustable, with a spongy stripe. Metal net shield.

P/N	DESCRIPTION	SCREEN DIMENSIONS Height mm	EAN13 CODE
5120901	Face screen extra-light Metal net shield	190	8032706104555

PACKAGING:
8 pcs x
Carton Box



Q.TY x MASTER PACK: 56 pcs
MASTER CARTON: 58x40x35 cm
TOTAL WEIGHT: 8 kg

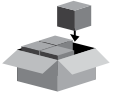

ORDER MULTIPLES OF: 56 pcs

certifications

CE SCREEN EN 1731-S

packaging



Adjustable, with a spongy stripe. Metal net shield.

P/N	DESCRIPTION	SCREEN DIMENSIONS Height mm	EAN13 CODE
5120922	Face screen Metal net shield	190	8032706104586

PACKAGING:
12 pcs x
Carton Box



Q.TY x MASTER PACK: 72 pcs
MASTER CARTON: 71x41x47 cm
TOTAL WEIGHT: 9 kg

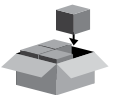

ORDER MULTIPLES OF: 72 pcs

certifications

CE SCREEN EN 1731-S

packaging



Face Shields



Adjustable, with a spongy stripe.

P/N	DESCRIPTION	SCREEN DIMENSIONS		EAN13 CODE
		Width mm	Thick. mm	
5120903	Face screen Polycarbonate shield	190	0,8÷1	8032706104562

PACKAGING:

8 pcs x
Carton Box



Q.TY x MASTER PACK: 56 pcs

MASTER CARTON: 58x40x35 cm

TOTAL WEIGHT: 8 kg

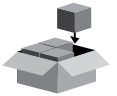

ORDER MULTIPLES OF: 56 pcs

certifications



SCREEN EN 166-B

packaging



Adjustable, with a spongy stripe.

P/N	DESCRIPTION	SCREEN DIMENSIONS		EAN13 CODE
		Width mm	Thick. mm	
5120921	Face screen extra-light Polycarbonate shield	190	0,8÷1	8032706104579

PACKAGING:

12 pcs x
Carton Box



Q.TY x MASTER PACK: 72 pcs

MASTER CARTON: 71x41x47 cm

TOTAL WEIGHT: 9 kg

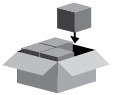

ORDER MULTIPLES OF: 72 pcs

certifications



SCREEN EN 166-B

packaging



Ear Muffs





certifications



CE MUFFS EN 352-1



certifications

CE MUFFS EN 352-1

P/N	DESCRIPTION	EAN13 CODE
5135902	CE approved ear muffs. SNR: 30 dB.	8032706104609
PACKAGING: 1 pc x Nylon Bag		Q.TY x MASTER BOX: 10 pcs CARTON BOX: 45x20x20 cm
		
		Q.TY x MASTER CARTON: 60 pcs MASTER CARTON: 63x42x46 cm
		
ORDER MULTIPLES OF: 10 pcs		

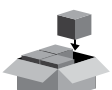
P/N	DESCRIPTION	EAN13 CODE
5135901	CE approved ear muffs. SNR: 27 dB.	8032706104593
PACKAGING: 1 pc x Nylon Bag		Q.TY x MASTER BOX: 10 pcs CARTON BOX: 45x20x20 cm
		
		Q.TY x MASTER CARTON: 60 pcs MASTER CARTON: 63x42x46 cm
		
ORDER MULTIPLES OF: 10 pcs		

Goggles



certifications

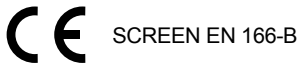

certifications

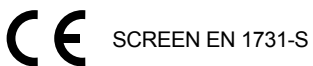

ShinGuards

for hobbyist and professionals



Designed to protect legs from knee down to ankle. Their components and production make them light, comfortable, easy-on, easy-off and at the same time strong and shock-resistant.

P/N	DESCRIPTION	EAN13 CODE
51809000	Shin guards, 1 pair	8032706102568

PACKAGING: 1 pair x Nylon Bag		Q.TY x MASTER PACK:	10 pairs
		MASTER CARTON:	50x23x44 cm
		TOTAL WEIGHT:	5,5 kg



ORDER MULTIPLES OF: 10 pcs

P/N	DESCRIPTION	EAN13 CODE
5130901	CE approved goggles. WITH NON FOGGING LENSES	8032706104616

PACKAGING: 1 pc x Nylon Bag		Q.TY x MASTER BOX:	20 pcs
		CARTON BOX:	37x21x10 cm

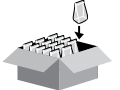

Q.TY x MASTER CARTON:	320 pcs
MASTER CARTON:	81x41x53 cm



ORDER MULTIPLES OF: 20 pcs

P/N	DESCRIPTION	EAN13 CODE
5130902	CE approved goggles. WITH NYLON MESH LENSES	8032706104623

PACKAGING: 1 pc x Nylon Bag		Q.TY x MASTER BOX:	20 pcs
		CARTON BOX:	37x21x10 cm



Q.TY x MASTER CARTON:	320 pcs
MASTER CARTON:	81x41x53 cm

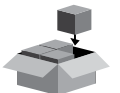

ORDER MULTIPLES OF: 20 pcs

Brushcutter Shoulder Straps



Shoulder strap

P/N	DESCRIPTION	EAN13 CODE
5150901	Simple and comfortable shoulder strap	8032706104647

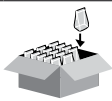
PACKAGING:		Q.TY x MASTER PACK: 50 pcs	
1 pc x		MASTER CARTON: 39,5x39x32 cm	
Nylon Bag		TOTAL WEIGHT: 8 kg	

ORDER MULTIPLES OF: 50 pcs



Shoulder strap - COMFORT

P/N	DESCRIPTION	EAN13 CODE
5150902	Simple shoulder strap with waist pad	8032706104654

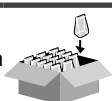
PACKAGING:		Q.TY x MASTER PACK: 25 pcs	
1 pc x		MASTER CARTON: 39,5x39,5x40,5 cm	
Nylon Bag		TOTAL WEIGHT: 9,5 kg	

ORDER MULTIPLES OF: 25 pcs



Shoulder strap - COMFORT PLUS

P/N	DESCRIPTION	EAN13 CODE
5150903	Double shoulder strap with waist pad. Safety quick release	8032706104661

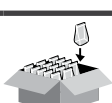
PACKAGING:		Q.TY x MASTER PACK: 20 pcs	
1 pc x		MASTER CARTON: 58x40x35 cm	
Nylon Bag		TOTAL WEIGHT: 9 kg	

ORDER MULTIPLES OF: 20 pcs



Shoulder strap - SUPER COMFORT

P/N	DESCRIPTION
5150904	Super comfort strap with waist pad. Safety quick release

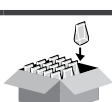
PACKAGING:		Q.TY x MASTER PACK: 5 pcs	
1 pc x		MASTER CARTON: 65x28x21 cm	
Nylon Bag		TOTAL WEIGHT: 3,5 kg	



ORDER MULTIPLES OF: 5 pcs

Universal Blade Guard



Universal plastic blade guard for Nylon heads and Nylon or Steel Blades. Mounting kit for shaft arms Ø 24 - 26 – 28 mm included. Metallic mounting clamps assure a perfect and durable fixing performance. Easy and handy assembling. Removable lower plastic guard allows the right blade usage.

P/N	DESCRIPTION	CUT Ø mm	TO FIT SHAFT Ø mm	EAN13 CODE
51109001	Universal mounting	380	24 / 26 / 28	8032706104685
51109000	plastic blade guard	420	24 / 26 / 28	8032706104678

PACKAGING: 1 pc x Nylon Bag  Q.TY x MASTER PACK: 40 pcs
 MASTER CARTON: 82,5x58,5x66 cm
 TOTAL WEIGHT: 23,5 kg 

ORDER MULTIPLES OF: 40 pcs

► highlights

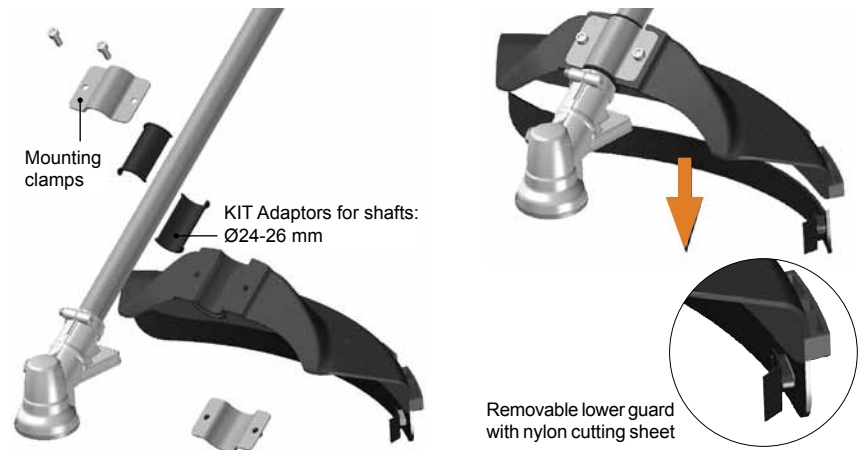

Blade Guard



Blade guard, nylon.
 To fit shaft Ø 24 - Ø 26 - Ø 28 mm standard.

P/N	DESCRIPTION	TO FIT SHAFT Ø mm	EAN13 CODE
5110901	Blade guard - nylon	24 / 26 / 28	8032706104692

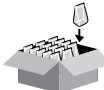
PACKAGING: 1 pc x Nylon Bag  Q.TY x MASTER PACK: 50 pcs
 MASTER CARTON: 58x40x35 cm
 TOTAL WEIGHT: 10,5 kg 

ORDER MULTIPLES OF: 50 pcs

Blade Guard



Blade guard, metal super.
To fit shaft Ø 24 - Ø 26 - Ø 28 mm.

P/N	DESCRIPTION	EAN13 CODE
5100902	Blade guard - metal super	8032706104715

PACKAGING: 1 pc x Nylon Bag		Q.TY x MASTER PACK: 50 pcs	
		MASTER CARTON: 58x40x35 cm	
		TOTAL WEIGHT: 21,5 kg	

ORDER MULTIPLES OF: 50 pcs



Blade guard, metal.
With adjustable rubber protection, best performance when using the nylon heads.

P/N	DESCRIPTION	EAN13 CODE
5100901	Blade guard - metal	8032706104708

PACKAGING: 1 pc x Nylon Bag		Q.TY x MASTER PACK: 40 pcs	
		MASTER CARTON: 58x40x35 cm	
		TOTAL WEIGHT: 27 kg	

ORDER MULTIPLES OF: 40 pcs

Blade Support



Blade support, metal, fix.

P/N	BORE mm
5250001	8
5250002	10

PACKAGING: 1 pc x Nylon Bag		Q.TY x MASTER PACK: 10 pcs	

ORDER MULTIPLES OF: 10 pcs



P/N	BORE mm
5250003	12
5250004	14

PACKAGING: 1 pc x Nylon Bag		Q.TY x MASTER PACK: 10 pcs	



ORDER MULTIPLES OF: 10 pcs

Plastic Cans



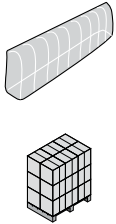

SPOUT L=150 mm
INCLUDED

Fuel Cans of best quality, delivered complete with flexible spout and cap. Handy and usefull for professional and private users.

P/N	DESCRIPTION	EAN13 CODE
51709001	Can 5 L	8032706104729
PACKAGING: Nylon Wrap		
Q.TY x MASTER PACK: 25 pcs		
NYLON WRAP: 120x80x28 cm		
TOTAL WEIGHT: 12,5 kg		
MAX Q.TY x PALLET: 225 pcs		
TOTAL WEIGHT: 132,5 kg		
ORDER MULTIPLES OF: 25 pcs		

certifications

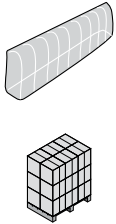

P/N	DESCRIPTION	EAN13 CODE
51709002	Can 10 L	8032706104739
PACKAGING: Nylon Wrap		
Q.TY x MASTER PACK: 16 pcs		
NYLON WRAP: 120x80x28 cm		
TOTAL WEIGHT: 11,5 kg		
MAX Q.TY x PALLET: 112 pcs		
TOTAL WEIGHT: 100,5 kg		
ORDER MULTIPLES OF: 16 pcs		

highlights



TRANSPORT

provided with following items



1 pc Complete spout L = 150 mm

SPARE PARTS



P/N	DESCRIPTION	ORDER MULTIPLES OF:
1 K00404002	Complete spout L=150 mm	4 pcs
2 K00404001	Complete spout L=250 mm	4 pcs
3 K00404000	Complete cap	4 pcs

PACKAGING:
Nylon Bag



Plastic Cans



SPOUT
NOT INCLUDED



Double use plastic can, red.

P/N	DESCRIPTION
-----	-------------

51709008	Can 3,5 L + 1,5 L
----------	-------------------

PACKAGING:	Nylon Wrap
Q.TY x MASTER PACK:	24 pcs
NYLON WRAP:	67x56x25 cm
TOTAL WEIGHT:	12,5 kg
MAX Q.TY x PALLET:	216 pcs
TOTAL WEIGHT:	132,5 kg

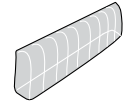

ORDER MULTIPLES OF: 24 pcs

accessories to be ordered separately

P/N K00404003

Complete spout with cap.
L=125 mm



PACKAGING:	Nylon Bag
Q.TY x MASTER PACK:	4 pcs



ORDER MULTIPLES OF: 4 pcs

highlights



OPTIONAL SPOUT L=125mm
Not included



TRANSPORT



COMBINATION WRENCH'S SLOT
Wrench not included

Plastic Cans



Double use plastic can, red.
High quality, light and resistant. Professional type.

P/N	DESCRIPTION	COLOR	EAN13 CODE
1 5170901	Can L 5 + 2,5 Professional type	Red	8032706101790
2 5170903	Can L 5 + 2,5 Professional type	White	8032706101806

PACKAGING: Carton Box
Q.TY x MASTER PACK: 4 pcs
MASTER CARTON: 35x38x38 cm
TOTAL WEIGHT: 4,2 kg



MAX Q.TY x PALLET: 144 pcs
TOTAL WEIGHT: 172,0 kg



ORDER MULTIPLES OF: 4 pcs

provided with following items



1 pc Complete spout

certifications

CERTIFIED  

SPARE PARTS



P/N	DESCRIPTION	ORDER MULTIPLES OF:
1 5170001	COMPLETE SPOUT	4 pcs
2 5170003	COMPLETE CAP	4 pcs

PACKAGING:
Nylon Bag



Double Use Plastic Can 6+3



Double use plastic can, red.
 High quality, light and resistant. Professional type.
 Capacity: fuel 6 L / oil 3 L.
 Provided with two easy fill spouts: one for fuel and one for oil
 System specially designed to ensure a fast filling, with automatic stop of the liquid when the tank is full.

P/N	DESCRIPTION	COLOR
51709011	Can L 6 + 3 Professional type	Red
51709012	Can L 6 + 3 Professional type	White

PACKAGING: Nylon Wrap
 Q.TY x MASTER PACK: 16 pcs
 NYLON WRAP: 80x120x34 cm
 TOTAL WEIGHT: 15,5 kg

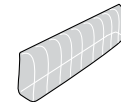

MAX Q.TY x PALLET: 96 pcs
 DIMENSIONS: 80x120x207 cm
 TOTAL WEIGHT: 113 kg



ORDER MULTIPLES OF: 16 pcs

certifications



provided with following items



1 pc FUEL spout - green



1 pc OIL spout - red

SPARE PARTS



P/N	DESCRIPTION	ORDER MULTIPLES OF:
1 51709009	COMPLETE EASY FILL SPOUT - FUEL	4 pcs
2 51709010	COMPLETE EASY FILL SPOUT - OIL	4 pcs
3 51709014	COMPLETE CAP	4 pcs

PACKAGING: Nylon Bag



Double Use Plastic Can 6+3

► highlights



TWO EASY FILL SPOUTS INCLUDED
One for fuel and one for oil.

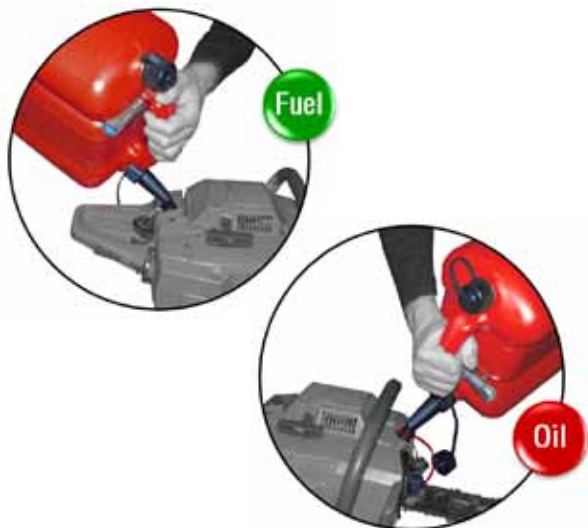

FUEL / OIL FILLING
Automatic stop of the liquid when the tank is full



FIT TWO COMBINATION WRENCHES IN THE RELEVANT SLOTS.
Wrenches not included

AUTO-FILL STOP

self-closing filler



Safety filler spout to prevent fuel leakage.

- Recommended to fill tanks of small petrol engines.
- Easy to fit on Tecomec cans.
- Also fits most of the popular fuel cans available on the market.

P/N	DESCRIPTION	EAN13 CODE
51709005	Self-closing spout	8032706103558

PACKAGING:
1 pc x
Hanger
Nylon Bag



Q.TY x MASTER PACK: 20 pcs
MASTER PACK: 33,5x21x28 cm
TOTAL WEIGHT: 3 kg

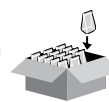

MAX Q.TY x CARTON: 160 pcs
MASTER CARTON: 71x43x60 cm
TOTAL WEIGHT: 25,5 kg

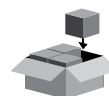

ORDER MULTIPLES OF: 20 pcs

► suitable for use on:

Tecomec dual-purpose cans



P/N 5170901



P/N 5170903



P/N 51709008

► highlights

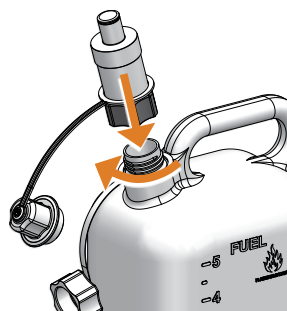

Easy to fit on Tecomec dual-purpose cans.

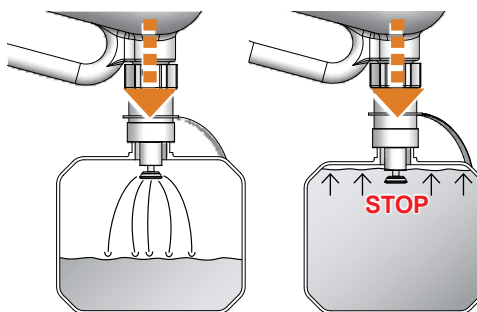

ON / OFF liquid flow to the full tank.

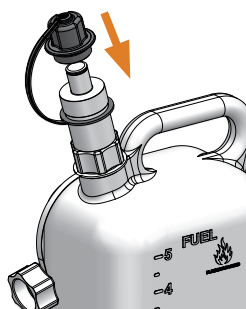

Complete with cap for protection and to prevent dirt.





Transport.

Funnel Assy Filter



P/N	DESCRIPTION	ORDER MULTIPLES OF:
1 5175901	Funnel assy - small	24 pcs
2 5175902	Funnel assy - medium	24 pcs
3 5175001	Funnel filter	10 pcs

PACKAGING:	1-2 → Carton Box	1-2	3
	3 → Nylon Bag		
Q.TY x MASTER PACK:	1-2 → 24 pcs		
	3 → 10 pcs		
MASTER CARTON:	1-2 → 42,5x28,5x36,5 cm		

Grease Stickers

for bevel gear pairs



Grease for bevel gear.

P/N	DESCRIPTION	EAN13 CODE
5160001	Grease stickers - 125 g	8032706104760

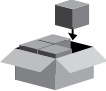
PACKAGING:	Carton Box Display	
Q.TY x PACK DISPLAY:	24 pcs	
TOTAL WEIGHT:	3,2 kg	
Q.TY x MASTER PACK:	192 pcs	
TOTAL WEIGHT:	27,0 kg	

MAX Q.TY x PALLET:	2304 pcs	
TOTAL WEIGHT:	345,0 kg	

ORDER MULTIPLES OF: 24 pcs

► highlights



PACKED IN A
BOX DISPLAY

Fuel Filters



Suitable for the following chain saws

FUEL FILTER "POREX" (HU TYPE)		OUR. REF.
Small "POREX"		524103
PACKAGING:	10 pcs x Nylon Bag	
Q.TY x MASTER PACK:	10 pcs	
ORDER MULTIPLES OF: 10 pcs		



Suitable for the following chain saws

FUEL FILTER ASSY (HU TYPE)		OUR. REF.
Small FELT		524901
PACKAGING:	10 pcs x Nylon Bag	
Q.TY x MASTER PACK:	10 pcs	
ORDER MULTIPLES OF: 10 pcs		



Suitable for the following chain saws

FUEL FILTER ASSY (HS TYPE)		OUR. REF.
Large FELT		524101
PACKAGING:	10 pcs x Nylon Bag	
Q.TY x MASTER PACK:	10 pcs	
ORDER MULTIPLES OF: 10 pcs		



Suitable for the following chain saws

SUPER TYPE - WITH INSIDE SINTERED ELEMENT		OUR. REF.
FUEL FILTER ASSY (standard fitting)		524123
FUEL FILTER ASSY (suitable for stihl)		524133
PACKAGING:	10 pcs x Nylon Bag	
Q.TY x MASTER PACK:	10 pcs	
ORDER MULTIPLES OF: 10 pcs		

Fuel Filters



Suitable for the following chain saws

FUEL FILTERS "POREX"	OUR. REF.
Ø 4,5 mm (suitable for HUSQVARNA)	524148
Ø 6,0 mm (suitable for TILLOTSON)	524154
Ø 7,5 mm (suitable for STIHL)	524155

PACKAGING: 10 pcs x Nylon Bag
 Q.TY x MASTER PACK: 10 pcs



ORDER MULTIPLES OF: 10 pcs

Suitable for the following chain saws



RUBBER FUEL LINE	OUR. REF.
inside Ø 3,2 mm x 1 m	524106
inside Ø 4,5 mm x 1 m	524107

MASTER PACK: 5 m x Nylon Bag

1 P/N and PRICE are referred to 1 m of fuel line

2 Order multiples of: 5 m (1 reel)

Starter Rope



Suitable for the following chain saws

DESCRIPTION	OUR. REF.
Spool Ø 3,0 mm x 100 m	560125
Spool Ø 3,5 mm x 100 m	560126
Spool Ø 4,0 mm x 100 m	560127
Spool Ø 4,5 mm x 100 m	560128

PACKAGING: Nylon Wrapp
 Q.TY x MASTER PACK: 1 pc



1 PRICE is referred to 100 m of rope (1 spool)

2 Order multiples of: 1 pc (1 spool)

Electrical Accessories



Suitable for the following chain saws

SPARK PLUG TERMINAL WITH SPRING		OUR. REF.
5 mm WIRE		506102
7 mm WIRE		506101
SPRING ONLY		506103
PACKAGING:	10 pcs x Nylon Bag	
Q.TY x MASTER PACK:	10 pcs	
ORDER MULTIPLES OF: 10 pcs		



Suitable for the following chain saws

SPARK PLUG TERMINAL WITH SPRING		OUR. REF.
STANDARD TYPE		506107
PACKAGING:	10 pcs x Nylon Bag	
Q.TY x MASTER PACK:	10 pcs	
ORDER MULTIPLES OF: 10 pcs		



Suitable for the following chain saws

SWITCH		OUR. REF.
UNIVERSAL TYPE		506110
PACKAGING:	10 pcs x Nylon Bag	
Q.TY x MASTER PACK:	10 pcs	
ORDER MULTIPLES OF: 10 pcs		



Electrical Accessories



Suitable for the following chain saws

RUBBER INSULATED CABLE FOR HIGH TEMPERATURES, FROM -20° ÷ +100°C	OUR. REF.
Ø 5 mm x 1 m	506142
Ø 7 mm x 1 m	506143

MASTER PACK: 10 m x Nylon Bag

1 P/N and PRICE are referred to 1 m of cable

2 Order multiples of: 10 m (1 reel)



Suitable for the following chain saws

INSULATED CABLE STANDARD	OUR. REF.
Ø 5 mm x 1 m	506111
Ø 7 mm x 1 m	506112

MASTER PACK: 10 m x Nylon Bag

1 P/N and PRICE are referred to 1 m of cable

2 Order multiples of: 10 m (1 reel)

Spark Plugs



Suitable for the following chain saws/engines

ENGINE	OUR REF.	HEXAGON	BOSCH	OUR REF. CHAMPION	NGK
CHAIN SAW BRUSH-CUTTERS	501157	19	WS7F	CJ7Y	BPM7A
CHAIN SAW	501159	19	WS7F	CJ8	BM6A
CHAIN SAW	501160	19	WKA200TRS	RCJ8Y	BPMR6A
CHAIN SAW	501161	19	WRS5F	RCJ7Y	BPMR7A
LAWN-MOWER	501158	21	W9ECO	J17LM	B4LM
HONDA	501162	21	WR6DC	RN10X	BPR6ES
HONDA	501163	21	WR6DCX	RN10Y4	BPR6ES-11
for lawnmower	501165	21			
FE55CP	00501000				

PACKAGING: 10 pcs x Carton Box

Q.TY x MASTER PACK: 280 pcs

MASTER CARTON: 38x36x15 cm

TOTAL WEIGHT: 11,5 kg

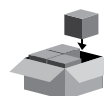

ORDER MULTIPLES OF: 280 pcs

Combination Wrenches

PACKAGING: Bulk
 Q.TY x MASTER PACK: 100 pcs
 MASTER CARTON: 29x19x24 cm
 TOTAL WEIGHT: 13 kg



ORDER MULTIPLES OF: 100 pcs

dimension

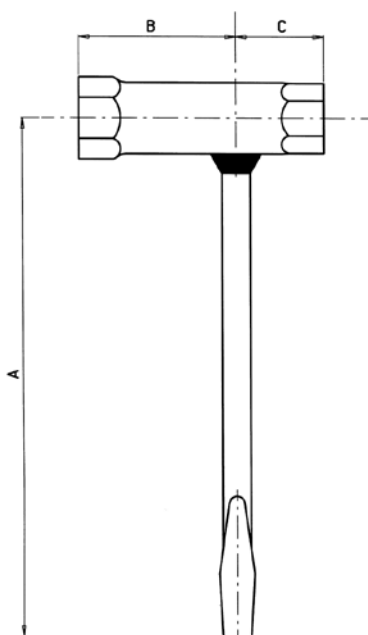

Suitable for the following chain saws

MAKE	OUR REF.	MODEL	DIMENSION				
			A mm	B mm	C mm	BAR mm	PLUG mm
ALPINA	2304023	A40-C40-CP45-A70-C70	150	52	33	13	19
CASTOR	2304084	490-C90	150	34	34	17	19
	2304014	CA-CC-CT	182	35	35	17	21
DOLMAR	2304084	122-123-144-152-153 133-166-309-310-311	150	34	34	17	19
	2304080	112-113-114-116-117-119 120-120 super	150	25	25	13	19
ECHO	2304023	CS60-100-452-500-601-605 650-701-750-801-802	150	52	33	13	19
	2304077	280-302-304-315-351-400	145	60	30	10	19
HOMELITE	2304020	XL Serie (1° mod.)-925	150	55	25	16	19
	2304017	Mini	150	45	25	13	16
	2304027	XL Super VI-XL2	150	90	25	11	16
	2304023	65-77 (2° mod.) 140-160 162-180-285-2100	150	52	33	13	19
HUSQVARNA	2304025	Husky	145	42	23	11	19
	2304080	61-154-181-234-266-44 444	150	25	25	13	19
JONSERED	2304080	625-630-670	150	25	25	13	19
MC CULLOCH	2304017	Standard	150	45	25	13	16
	2304027	Mac 6	150	90	25	11	16
	2304077	E140-E160-E1500-E1700 E1900-233-240-935X-935DX	145	60	30	10	19
	2304023	254-350-355-592-930-931 938-941-942-945-946-947 950-951-956-962-970-971 980-981	150	52	33	13	19
	2304084	271-272-481-482-999	150	34	34	17	19
PARTNER	2304025	330-340	145	42	23	11	19
	2304023	R16-R17-R18-S50-S55 P55-P70-P100	150	52	33	13	19
PIONEER	2304025	P12	145	42	23	11	19
	2304023	P20-P21-P25-P26-P28-P40 P50-1200-1074-C55	150	52	33	13	19
	2304084	P41-P51 Farmsaw-P60	150	34	34	17	19
POULAN	2304024	200-300-400	150	54	24	14	19
QUADRA	2304025	Frontier	145	42	23	11	19
SOLO	2304014	50-70-125	172	35	35	17	21
	2304023	610-620-640-650	150	52	33	13	19
STIHL	2304010	010-015-020-028-031 032-041	170	50	18	13	19
	2304008	010-015-020-028-031 032-041	170	21	34	13	19
	2304084	045-050-051-070-075	150	34	34	17	19
	2304014	08	182	35	35	17	21

Combination Wrenches



Suitable for the following chain saws

MAKE	OUR REF.	
STIHL	2304072	Wrench for Stihl screws (TORX 27)

PACKAGING: Bulk
 Q.TY x MASTER PACK: 100 pcs
 MASTER CARTON: 21x18x13 cm
 TOTAL WEIGHT: 3 kg



ORDER MULTIPLES OF: 100 pcs



Suitable for the following chain saws

MAKE	OUR REF.	
STIHL	2304074	Allen wrench for Stihl screws (TORX 27)

PACKAGING: Bulk
 Q.TY x MASTER PACK: 100 pcs
 MASTER CARTON: 29x19x24 cm
 TOTAL WEIGHT: 13 kg



ORDER MULTIPLES OF: 100 pcs



Suitable for the following chain saws

MAKE	OUR REF.	
ASPERA	2304083	21 x 19 x 11 Square-Aspera and Tecumsen
BRIGGS & STRATTON	2304076	21 x 19 x 3/8 Square-Briggs & Stratton Sprint

PACKAGING: Bulk
 Q.TY x MASTER PACK: 100 pcs
 MASTER CARTON: 35x27x20 cm
 TOTAL WEIGHT: 17,5 kg



ORDER MULTIPLES OF: 100 pcs

CONDIZIONI GENERALI DI VENDITA

Art. 1 - Ambito di applicazione delle condizioni generali di vendita

1.1 Le presenti condizioni generali di vendita (di seguito le "Condizioni") si applicano a ogni contratto di vendita (di seguito il "Contratto") concluso da Tecomec (di seguito il "Venditore") ed avente ad oggetto i prodotti fabbricati e/o commercializzati dal Venditore (di seguito i "Prodotti").

1.2 Nonostante qualunque previsione contraria, anche se contenuta nelle eventuali condizioni generali dell'Acquirente dei Prodotti (di seguito l'"Acquirente"), ogni offerta, conferma d'ordine e/o consegna da parte del Venditore si intende regolata dalle seguenti Condizioni, salvo patto contrario specificatamente accettato di volta in volta per iscritto dal Venditore.

Art. 2 - Conclusione ed entrata in vigore del Contratto

2.1 Il Contratto di vendita dei Prodotti si intende concluso (i) nel momento di emissione della relativa conferma d'ordine da parte del Venditore o, in mancanza di tale conferma, (ii) nel momento del ritiro dei Prodotti da parte dell'Acquirente.

2.2 Gli ordini dell'Acquirente saranno accettati dal Venditore solo a condizione che contengano le specifiche necessarie ad identificare i Prodotti ordinati, restando inteso che il Venditore si riserva la facoltà di accettare o rifiutare gli ordini dell'Acquirente a proprio insindacabile giudizio.

2.3 Eventuali annullamenti o modifiche dell'ordine da parte dell'Acquirente, successivi alla conclusione del Contratto di cui al precedente art. 2.1, non avranno effetto se non preventivamente autorizzati o successivamente accettati per iscritto dal Venditore (fermo restando che in nessun caso agenti, intermediari e/o collaboratori esterni del Venditore hanno il potere di accettare per conto di quest'ultimo gli ordini di acquisto dell'Acquirente e/o di formulare o accettare, in modo vincolante per il Venditore, proposte relative a sconti, abbuoni e/o condizioni derogative alle presenti Condizioni).

Art. 3 - Modalità di pagamento – Prezzi

3.1 Se non altrimenti convenuto per iscritto, ad ogni ordine si applicano i prezzi di listino praticati dal Venditore al momento della conferma d'ordine. I prezzi di eventuali Prodotti non riportati a listino saranno determinati di volta in volta dal Venditore.

3.2 I prezzi dei Prodotti si intendono al netto di IVA e di ogni altra spesa e/o onere accessorio (quali, in via esemplificativa e non limitativa, spese e/o commissioni bancarie, imballo speciale, assicurazione, trasporto), che devono intendersi quindi a carico dell'Acquirente. Fermo quanto precede, le imposte, le tasse, i tributi, le licenze, le autorizzazioni, i permessi ed ogni e qualsivoglia costo o adempimento fiscale, doganale ed amministrativo da cui dipendano l'importazione e/o la rivendita dei Prodotti devono ritenersi ad esclusivo carico dell'Acquirente ovvero svolte dal Venditore sotto l'esclusiva responsabilità dell'Acquirente ed a rischio e spese di quest'ultimo.

3.3 Salvo diversa indicazione scritta nella conferma d'ordine, il pagamento del prezzo dei Prodotti sarà effettuato entro 30 (trenta) giorni dalla data di emissione della fattura. Per nessun motivo l'Acquirente potrà ritardare o sospendere i pagamenti del prezzo dei Prodotti. Qualora l'Acquirente non adempia regolarmente ai propri obblighi di pagamento del prezzo (compreso l'inadempimento dell'obbligo di versare gli eventuali anticipi), il Venditore avrà la facoltà di prorogare i termini di consegna pattuiti per un periodo corrispondente al ritardo dell'Acquirente e/o di risolvere il Contratto, ritenendo come penale le somme pagate dall'Acquirente, salva in ogni caso la risarcibilità del danno ulteriore.

Art. 4 - Termini di consegna ed imballo

4.1 Tutte le date indicate nelle conferme d'ordine come termini di consegna si intendono puramente indicative. Eventuali ritardi nella consegna non daranno diritto all'Acquirente alla risoluzione del Contratto, né al risarcimento dei danni di qualsiasi natura (fermo in ogni caso restando che l'Acquirente, mediante il ritiro della consegna tardiva, rinuncia a qualsivoglia pretesa in relazione al ritardo).

4.2 Salvo diverso accordo scritto tra le parti, la consegna dei Prodotti (così come il passaggio del relativo rischio) ha luogo secondo la formula "EX WORKS – franco fabbrica venditore" (Incoterms 2000); per effetto di quanto precede, il Venditore non stipulerà alcun contratto di spedizione o trasporto e non assicurerà i Prodotti oggetto di fornitura se non dietro espresso ordine dell'Acquirente, restando in ogni caso a carico di quest'ultimo tutti i conseguenti oneri e rischi.

4.3 L'Acquirente si impegna a ritirare i Prodotti immediatamente dopo aver ricevuto la comunicazione di merce pronta e comunque non oltre 8 (otto) giorni dalla data della predetta comunicazione. Il passaggio del rischio comincerà in ogni caso a decorrere dalla predetta data di avviso di merce pronta ovvero, solo in mancanza di questa, dalla data di consegna.

4.4 All'atto della consegna dei Prodotti, l'Acquirente è tenuto a controllarne numero e tipologia. Qualsiasi reclamo da parte dell'Acquirente in relazione alla quantità e alla qualità dei Prodotti consegnati deve pervenire in forma scritta al Venditore entro e non oltre 8 (otto) giorni dalla data di consegna dei Prodotti stessi.

4.5 I Prodotti sono consegnati dal Venditore all'Acquirente muniti di imballo adeguato. Resta inteso che il Venditore fornisce un imballo idoneo ad una permanenza delle merci in deposito/transito per un periodo non superiore a 180 (centottanta) giorni; qualora l'Acquirente comunichi con sufficiente anticipo che le merci potranno essere in deposito/transito per un periodo superiore a 180 (centottanta) giorni, il Venditore potrà fornire a spese dell'Acquirente un diverso imballo.

4.6 Con la consegna dei Prodotti, l'Acquirente si impegna a custodire con la dovuta diligenza i Prodotti ricevuti (conservandoli in luogo sicuro ed idoneo e facendo in modo che i Prodotti non siano sottoposti a condizioni climatiche e temperature inadeguate), posto che la proprietà dei Prodotti passerà all'Acquirente solo in seguito al saldo integrale del prezzo. In caso di mora dell'Acquirente nel pagamento del prezzo, il Venditore potrà, senza necessità di alcuna formalità, compresa la messa in mora, riprendere possesso di tutti i Prodotti oggetto di riservato dominio ovunque essi si trovino, nonché addebitare gli interessi di mora nella misura prevista dalla legge applicabile in materia (fermo restando il diritto del Venditore a ricorrere ad ogni ulteriore rimedio di legge circa il pregiudizio subito).

Art. 5 - Caratteristiche dei Prodotti; Modifiche ai Prodotti

5.1 Eventuali informazioni o dati sulle caratteristiche e/o specifiche tecniche dei Prodotti contenuti nei depliant, listini prezzi, cataloghi, o documenti similari sono puramente indicativi e non vincolanti, salvo espresso accordo scritto in tal senso tra le parti.

5.2 L'Acquirente non potrà effettuare, direttamente o indirettamente, alcuna modifica, cambiamento o qualsiasi altra alterazione dei Prodotti e sopporterà ogni e più ampia responsabilità in relazione ai Prodotti, sia essa prevedibile o non prevedibile, derivante dal Contratto, da fatto illecito, da equità o altro, nel caso di suo inadempimento alle sopra citate obbligazioni.

5.3 Fermo restando quanto precede, il Venditore si riserva, a proprio insindacabile giudizio, il diritto di aggiornare, modificare e/o terminare la produzione di tutte o alcune tipologie di Prodotti. A tale riguardo, l'Acquirente riconosce ed accetta altresì che i cambiamenti della tecnologia, delle condizioni di mercato o della politica delle vendite del Venditore consentono al Venditore stesso di modificare le specifiche di un Prodotto o di cessare la produzione e/o la vendita di uno o più tipologie di Prodotto. Resta comunque inteso che il Venditore non sarà in nessun caso ritenuto responsabile nei confronti dell'Acquirente e/o di terzi per gli eventuali danni, diretti o indiretti, che possano prodursi a seguito di una decisione del Venditore in tal senso.

Art. 6 - Responsabilità

6.1 Fermo restando le limitazioni della garanzia del Venditore di cui al successivo art. 7, in nessun caso la responsabilità complessiva del Venditore potrà eccedere il 7% (sette per cento) del prezzo pattuito in relazione ai Prodotti oggetto di contestazione.

6.2 L'Acquirente si impegna a prendere visione e conoscenza delle caratteristiche tecniche dei Prodotti, nonché delle istruzioni e delle avvertenze fornite in relazione all'uso che si può fare dei suddetti Prodotti ed al quale i medesimi Prodotti possono essere ragionevolmente destinati. Oltre a ciò, l'Acquirente si impegna a fare in modo che i Prodotti siano commercializzati unicamente a partire dal momento in cui i medesimi Prodotti rispettino tutte le leggi, i regolamenti e le altre normative (relative a imballi, istruzioni, informazioni e, più in generale, alla sicurezza delle cose e delle persone) previste dall'ordinamento del Paese in cui i Prodotti vengono commercializzati. Spetterà pertanto esclusivamente all'Acquirente – che si impegna pertanto a manlevare ed a tenere pienamente indenne il Venditore con riferimento a quanto previsto dal presente art. 6.2 – assicurare che l'utilizzo e la commercializzazione dei Prodotti risulti corretto e conforme alle suddette norme nonché alle esigenze della propria clientela ed alla buona tecnica.

Art. 7 - Garanzia

7.1 Il Venditore garantisce la qualità dei Prodotti per un periodo di 12 (dodici) mesi dalla consegna, salvo le tolleranze d'uso ed esclusi quei difetti che possano manifestarsi a causa del trasporto, di un uso improprio o di una inadeguata conservazione o manutenzione dei Prodotti. Dalla presente garanzia sono esclusi tutti gli ulteriori danni, ivi compresi quelli derivanti dalla mancata o ridotta produzione, nonché quelli indiretti e consequenziali, speciali, incidentali e/o di carattere sanzionatorio.

7.2 La garanzia è subordinata, a pena di decadenza, alla denuncia del vizio o della mancanza di qualità, comunicata in forma scritta al Venditore, entro 8 (otto) giorni dal momento in cui l'Acquirente ne ha fatto la scoperta, nonché all'espressa richiesta, sempre comunicata nelle forme indicate, al Venditore di effettuare un intervento in garanzia.

7.3 La garanzia consiste, a scelta del Venditore, nella riparazione o sostituzione, a cura e spese del Venditore, dei Prodotti che risultino rotti o difettosi per vizi di origine. Il Venditore provvede alla sostituzione ovvero alla riparazione nel più breve tempo possibile (da stabilire di volta in volta) ed ha facoltà di richiedere all'Acquirente la restituzione delle parti e/o dei Prodotti sostituiti.

7.4 Ogni diversa garanzia in relazione ai Prodotti, anche di legge, deve ritenersi esclusa e superata dalle presenti Condizioni.

Art. 8 - Resi

8.1 I Prodotti potranno essere resi dall'Acquirente al Venditore solo previa autorizzazione del Venditore stesso. Resta in ogni caso inteso che, in assenza del ritiro dei Prodotti, da parte dell'Acquirente, entro 6 (sei) mesi dalla data del relativo reso al Venditore (a prescindere dal fatto che si tratti di resi non autorizzati o di Prodotti fuori garanzia), il Venditore si riserva la facoltà di rottamare i Prodotti in questione e di addebitare all'Acquirente il costo di tale operazione, fermo restando in ogni caso il diritto del Venditore al rimborso del costo del deposito dei Prodotti resi.

Art. 9 - Forza maggiore

9.1 Il Venditore non è responsabile nei confronti dell'Acquirente di alcun inadempimento, compresa la mancata o ritardata consegna, causato da accadimenti al di fuori del proprio ragionevole controllo o comunque riconducibili a caso fortuito o a forza maggiore, quali, a titolo meramente indicativo, mancata o ritardata consegna dei materiali di lavorazione da parte dei fornitori, scioperi ed altre azioni sindacali, sospensione dell'energia elettrica o difficoltà nei trasporti.

9.2 Al verificarsi di un evento di forza maggiore gli obblighi delle parti che non possano essere adempiuti per tale causa sono automaticamente prorogati, senza penalità a carico, per un periodo corrispondente alla durata dello stato di forza maggiore; quanto precede, ad eccezione dell'obbligo dell'Acquirente di corrispondere le somme dovute a titolo di pagamento del prezzo, per il quale restano in ogni caso ferme le scadenze precedentemente pattuite.

Art. 10 - Legge applicabile e foro competente

10.1 Le presenti Condizioni e tutti i contratti di vendita di cui siano parte il Venditore e l'Acquirente sono esclusivamente regolati dalla legge italiana (con conseguente applicazione delle disposizioni della Convenzione di Vienna dell'11 aprile 1980 sui contratti di vendita internazionale di beni mobili, nella misura in cui non derogate dalle clausole del presente Contratto).

10.2 Foro competente in via esclusiva per tutte le controversie relative alla sottoscrizione, all'interpretazione, all'esecuzione ed allo scioglimento per qualsivoglia motivo delle presenti Condizioni e di tutti i contratti di vendita di cui siano parte il Venditore e l'Acquirente è quello della sede legale del Venditore, salva la facoltà per quest'ultimo di convenire l'Acquirente davanti ad ogni Foro avente giurisdizione nei confronti dell'Acquirente stesso.

GENERAL CONDITIONS OF SALE

Art. 1 - Scope of application of the General Conditions of Sale

1.1 - These general conditions of sale (hereinafter the "Conditions") shall apply to every contract of sale (hereinafter the "Contract") entered into by Tecomec (hereinafter the "Seller") which concerns the products manufactured and/or marketed by the Seller (hereinafter the "Products").

1.2 - Notwithstanding any provision to the contrary and even if any such provision may be contained in any possible general conditions of the buyer of the Products (hereinafter, the "Buyer"), the Conditions shall apply to any offer, any order confirmation and any delivery effected by the Seller, except as expressly provided from time to time in a written document signed by the Seller.

Art. 2 - Conclusion and effective date of each Contract

2.1 - The Contract of sale of the Products shall be deemed to enter into force (i) at such time as the Seller issues the relevant order confirmation, or in absence of such an order confirmation, (ii) at such time as the Buyer collects the Products.

2.2 - The Buyer's orders will be accepted by the Seller only if said orders contain the specifications which are necessary for the purpose of identifying the Products ordered, it being understood that the Seller shall be entitled, at its sole discretion, to accept or refuse the Buyer's orders.

2.3 - Any possible cancellation of or amendment to any order by the Buyer shall not be effective unless previously authorised or subsequently accepted in writing by the Seller (it being in any event understood that the Seller's commercial agents, intermediaries and/or external consultants shall not have the power to accept the Buyer's orders on behalf of the Seller and/or to formulate or accept any proposal, in such a way as to bind the Seller, relating to discounts, sales allowances and/or variations to the Conditions).

Art. 3 - Terms of payment and Prices

3.1 - Unless otherwise agreed in writing, the Seller's price list which is in force as of the date of the order confirmation shall apply to any order made by the Buyer. The prices of any Products not appearing on the price list shall be determined by the Seller on a case by case basis.

3.2 - The prices of the Products shall be deemed exclusive of VAT and of any other incidental expense and/or cost (including, but not limited to, bank commissions or expenses, special packaging, insurance, transport), which shall be borne by the Buyer. Without prejudice to the above, any and all taxes, duties, levies, licences, authorisations, permits and any and all tax and administrative or customs formalities or costs relating to the importation and/or re-sale of the Products shall be borne and carried out exclusively by the Buyer or, alternatively, they may be carried out by the Seller at the Buyer's sole risk, expense and responsibility.

3.3 - Unless otherwise indicated in the order confirmation, payment of the price of the Products will be effected within 30 (thirty) days following the date of issue of the relevant invoice. Under no circumstances shall the Buyer be entitled to suspend or delay payment of the Products. In the event that the Buyer fails to fulfil its obligations to pay the price (including the obligation to make any possible advance payments), the Seller shall be entitled to postpone the delivery of the Products for a period corresponding to the length of the delay on the part of the Buyer and/or to terminate the Contract, retaining the sums received from the Buyer by way of liquidated damages, without prejudice to the Seller's rights to claim compensation for any further damages suffered.

Art. 4 - Terms of delivery and packaging

4.1 - All delivery dates as well as delivery terms given in the order confirmation shall be deemed to be indicative only. In the event of possible late delivery, the Buyer shall not be entitled to terminate the Contract or claim compensation for damages of whatever nature (it being in any event understood that by collecting any Products which may have been delivered late, the Buyer waives any and all rights relating to said delay).

4.2 - Unless otherwise agreed in writing between the parties, the delivery of the Products (and the relating transfer of risk) will be effected "EX WORKS" (Incoterms 2000); in the light of the above, the Seller shall not enter into any shipment or transportation agreement and shall not insure the Products to be supplied, unless the Buyer should so expressly instruct the Seller in writing; it being in any event understood that any and all risks and expenses in relation thereto shall be borne exclusively by the Buyer.

4.3 - The Buyer agrees to collect the Products as soon as it receives notice that the Products are ready and at its disposal and, in any event, within 8 (eight) days of the date of said notice. In any event, the transfer of risk and the payment terms shall start running as of the date of the notice that the Products are ready or, in the absence thereof, as of the date of delivery.

4.4 - At the time of delivery of the Products the Buyer shall check the quantity and the specifications of the Products delivered. Any claim by the Buyer in respect of the quantity or the quality of the delivered Products shall be communicated in writing to the Seller within no more than 8 (eight) days following the date of delivery of the Products.

4.5 - The Products shall be delivered by the Seller to the Buyer with appropriate packaging; it being understood that the packaging provided by the Seller is suitable for a period of storage/transit not exceeding 180 (one hundred and eighty) days. Provided that the Buyer advises the Seller sufficiently in advance that the goods may be in storage/transit for a period exceeding 180 (one hundred and eighty) days, then the Seller may supply the Buyer, at the latter's expense, with different packaging.

4.6 - From such time as the Products are delivered, the Buyer undertakes to look after the Products with the requisite care (keeping them in a safe and appropriate place and in such a way that they are not subjected to inappropriate climatic conditions and temperatures), given that the ownership of the Products shall pass to the Buyer only upon payment in full of the sale price of the Products. In the event that the Buyer fails to pay the price, the Seller shall be entitled, without any formalities, including sending a notice of default, to repossess all of the Products with respect to which title has not yet passed to the Buyer, wherever said Products may be; in addition, the Seller shall be entitled to charge interest on arrears at the rate provided by the applicable law (without prejudice to the Seller's right to seek any other judicial remedies available to it in respect of the damages suffered).

Art. 5 - Characteristics of the Products; Modifications to the Products

5.1 - Any possible information or data relating to the characteristics and/or to the technical specifications of the Products that may be included in brochures, price lists, catalogues, or similar documents are indicative only and not binding, unless otherwise agreed in writing by the parties.

5.2 - The Buyer shall be prohibited from making, directly or indirectly, any changes, modifications or other alterations whatsoever to the Products and should the Buyer breach such obligations, it shall bear any and all liability in respect of the Products, be it foreseeable or unforeseeable, arising out of the Contract, any unlawful act, in equity or otherwise.

5.3 Without prejudice to the above terms, the Seller reserves the right to update, modify or terminate the production of all or any of the Products as determined by the Seller at its sole discretion.

In this regard, the Buyer acknowledges and agrees that changes in technology or in market conditions or in the Seller's sales and marketing policy may prompt the Seller to modify the Product specifications or to cease to manufacture or sell one or more types of the Products and that the Seller shall not be in any way liable to the Buyer for any possible damages, be they direct or indirect, which may be suffered by the Buyer as a result of such decision by the Seller.

Art. 6 - Liability

6.1 - Without prejudice to the limitations of the warranty as per Art. 7 below, the Seller's total liability may not in any event exceed an amount equal to 7% (seven percent) of the price agreed for the Products in respect of which the claim occurs.

6.2 - The Buyer undertakes to read and make itself acquainted with the specifications of the Products and the instructions and warnings supplied in relation to the use that may be made of said Products and the use for which the Products may be reasonably intended. In addition, the Buyer shall ensure that the Products will only be marketed as of such time as they comply with all laws, regulations and other rules (relating to packaging, instructions, information, and in general, to the safety of persons and goods) provided by the country in which the Products will be marketed. The Buyer shall be solely responsible for ensuring that the use and marketing of the Products are correct and in compliance with the above-mentioned regulations and laws, in addition to the requirements of the Buyer's customers and good technique and the Buyer shall indemnify and hold the Seller harmless with regard to the terms of this Art. 6.2.

Art. 7 - Warranty

7.1 - The Seller warrants the quality of the Products for a period of 12 (twelve) months following the date of delivery, subject to the customary tolerances and excluding those defects which may arise due to transportation, improper use or inappropriate storage or maintenance of the Products. Any other damages, including any possible damages resulting from the lack of or a reduction in production, in addition to any indirect, consequential, special or incidental or damages of a punitive nature, are expressly excluded from the warranty.

7.2 - The warranty shall be subject to the Buyer duly informing the Seller in writing, within 8 (eight) days following the discovery thereof, of the particular defect or lack of quality, failing which the Buyer shall lose its rights under the warranty in respect thereof, and shall also be subject to the Buyer making an express written request to the Seller to provide assistance under the warranty.

7.3 - The warranty consists in either the repair or replacement, at the Seller's sole discretion and at its expense, of the Products which may prove to be broken or defective due to manufacturing defects. The Seller shall replace or repair the defective parts in the shortest time possible (which shall be calculated on a case by case basis) and the Seller shall have the right to request the Buyer to return the defective parts and/or the Products which have been replaced.

7.4 - Any other warranty relating to the Products, including without limitation, any warranties provided by law, shall be deemed excluded and superseded by these Conditions.

Art. 8 - Returned Products

8.1 - The Products may be returned by the Buyer to the Seller only if the Seller has given its prior written authorisation in relation thereto. It is in any event understood that if the Buyer does not collect the Products within a period of 6 (six) months after they have been returned to the Seller (regardless of whether the return is unauthorised or in relation to Products which are no longer under warranty), the Seller shall be entitled to scrap said Products and to charge the Buyer the relevant costs, without prejudice to the Seller's right to be reimbursed by the Buyer for the costs relating to the storage of the returned Products.

Art. 9 - Force Majeure

9.1 - The Seller shall not be liable vis-à-vis the Buyer for any failure to perform, including late delivery or failure to deliver, which is caused by occurrences beyond the Seller's reasonable control or in any case caused by an event of force majeure, including, but not limited to, late delivery or non-delivery of manufacturing materials by suppliers, strikes and other trade union actions, suspension of electrical energy or difficulties in transportation.

9.2 - Upon the occurrence of any event of force majeure which is such as to prevent either party hereto from fulfilling its obligations hereunder, then the time for the party so affected to fulfil its obligations shall be automatically extended for a period corresponding to the duration of the event of force majeure, save for the Buyer's obligation to pay the amounts due by way of the price, in respect of which the contractually agreed due dates shall remain in full force and effect.

Art. 10 - Applicable Law and jurisdiction

10.1 - These Conditions and all contracts of sale to which the Seller and the Buyer are a party shall be exclusively governed by Italian law (including the provisions of the Vienna Convention 1980, relating to contracts for the international sale of goods, which are not derogated by these Conditions).

10.2 - Any and all disputes arising out of or relating to the signing, interpretation, execution and termination for any reason whatever of these Conditions and of the contracts of sale to which the Seller and the Buyer are a party, shall be settled exclusively by the courts of competent jurisdiction for the place in which the Seller's registered office is located. Notwithstanding the foregoing, the Seller may bring an action against the Buyer before any court having jurisdiction over the Buyer.

This catalogue replaces any previous ones.

The information included in this catalogue simply intend to identify the product.

The user must choose and install the products according to the applicable laws and current safety regulation.

The products included in this catalogue are for the exclusive use of professional workers able to choose the right product, granting its better employment.

Pictures, dimensions, features and coding can be changed or modified without prior notice. The documentation available by our Technical Department offers the appropriate updating.

For more detailed information concerning features and use of the products included in this catalogue, please contact our Technical Department.

All rights reserved
Tecomec S.r.l.



This catalogue has been printed using vegetal inks and no process plates.

Tecomec S.r.l.

Tecomec S.r.l. Strada della Mirandola, 11
42124 Reggio Emilia - ITALY
Tel. +39 0522 959001 Fax +39 0522 959060
salesdept@tecomec.com
www.tecomec.com



CERTIFIED
QUALITY SYSTEM
UNI EN ISO 9001



P00802007_R08 08/2013

